

MANDATORY SERVICE BULLETIN NO.

MSB 40-103 / MSB F4-042 / MSB D4-114 / MSB 40NG-084

I TECHNICAL DETAILS

I.1 Category

Mandatory.

I.2 Airplanes Affected

Type: DA 40 / DA 40 D / DA 40 F / DA 40 NG

S/N:

DA40 NG

- D4.111, D4.365.
- 40.NS001, 40.NS002.
- 40.NC001 to 40.NC342, and 40.NC345.
- 40.N001 to 40.N660.
- 40.NF001-40.NF111.

DA40

- 40.006 to 40.009, 40.011 to 40.079 and 40.081 to 40.083.
- 40.201 to 40.212, 40.214 to 40.1251.

DA 40 F

- 40.FC001 to 40.FC029.

DA 40 D

- 40.080, 40.084.
- D4.001 to D4.012, D4.014 to D4.110, D4.112 to D4.197, D4.202 to D4.245, D4.247 to D4.361, D4.363, D4.364, D4.366 to D4.378, D4.381, D4.382, D4.389, D4.392, D4.399.
- 40.DS001 to 40.DS172, 40.DS174 and 40.DS175.

I.3 Date of Effectivity

20 March 2025.

I.4 Time of Compliance

At the next scheduled maintenance action from the date of effectivity, latest within the next 100 flight hours or 100 days, whichever comes first.

For airplanes with less than 100 flight hours accumulated:

- Accomplish the following instructions of Section III of the Work Instructions:
Paragraphs: 1, 5, 19 to 24, 26, 28, 30, 31, 33 to 38.

For airplanes with 100 flight hours or more accumulated:

- Accomplish all inspections and modifications in accordance with Section III of the Work Instructions.

I.5 Subject

Actions to prevent Passenger Door Separation: Installation of Placards, AFM Procedure update and Inspection/Data Gathering.

ATA-Code: 52-20

I.6 Reason

Diamond Aircraft Industries have received reports of passenger door separating from aircraft during flight. In some cases, operators forgot to latch the passenger door before flight and that there have been attempts to latch the door during flight, which led to separation of the passenger door.

This Service Bulletin implements updated Aircraft Flight Manual (AFM) procedures and placards to prevent passenger door separation caused by human factors. The Service Bulletin also gives instructions for a detailed inspection of the passenger door latching and safety hook mechanisms. Results of the inspection are to be reported to Diamond Aircraft Industries Inc. to gather fleet data for further investigation.

I.7 Concurrent Documents

None.

I.8 Approval

The technical content of this document relates to the Design Change Advisory No. MÄM 40-1203, which has been approved as part of the type design.

I.9 Accomplishment/Instructions

See WI-MSB 40-103 / WI-MSB F4-042 / WI-MSB D4-114 / WI-MSB 40NG-084 section III, latest effective issue.

I.10 Mass (Weight) and CG

The change in mass and CG is negligible.

II PLANNING INFORMATION

II.1 Material and Availability

See WI-MSB 40-103 / WI-MSB F4-042 / WI-MSB D4-114 / WI-MSB 40NG-084, latest effective issue.

II.2 Special Tools

None.

II.3 Labour Effort

Approximately 3 hours in addition to the inspections already required in the AMM and replacements (if necessary).

II.4 Credit

For all aircraft within warranty period.

II.5 Reference Documents

DA 40 Series Airplane Maintenance Manual, Doc. No. 6.02.01, latest effective issue.

DA 40 NG Airplane Maintenance Manual, Doc. No. 6.02.15, latest effective issue.

III REMARKS

1. All work must be done by a certified aircraft service station or a certified aircraft maintenance mechanic.
2. All work, in particular which is not especially described in this Service Bulletin, must be done in accordance with the referenced maintenance manual.
3. Completion of all work must be recorded in the logbook.
4. If material and/or labor hours are subject to be credited through Diamond Aircraft Industries, the Service Bulletin must be done by an authorized Diamond Service Center within the time of compliance and the Warranty Application incl. Work Report must be sent not later than 30 days after completion of work.
5. In case of doubt, contact Diamond Aircraft Industries Inc.
6. If any replacement or repair was done using the Work Instruction (WI), repeat the WI to ensure proper operation of the passenger door.

WORK INSTRUCTION

WI-MSB 40-103 / WI-MSB F4-042 / WI-MSB D4-114 / WI-MSB 40NG-084

I GENERAL INFORMATION

I.1 Subject

Installation of passenger door placards and inspection of the passenger door system.

ATA code: 52-10

I.2 Reference Documents

DA 40 Series Airplane Maintenance Manual, Doc. No. 6.02.01, latest effective issue.

DA 40 NG Airplane Maintenance Manual, Doc. No. 6.02.15, latest effective issue.

I.3 Remarks

1. All work must be done by a certified aircraft service station or a certified aircraft maintenance mechanic.
2. All work, in particular which is not especially described in this work instruction, must be done in accordance with the referenced maintenance manual.
3. In case of doubt, contact Diamond Aircraft Industries Inc.
4. If any replacement or repair was done using this Work Instruction (WI), repeat the WI to ensure proper operation of the passenger door.

II DRAWINGS, SPECIAL TOOLS & MATERIALS

II.1 Drawings

None.

II.2 Special Tools

None.

II.3 Material

Item	Quantity	Part Number	Description
1	1	D60-1133-10-08	Information Placard - Passenger door
2	1	D60-1133-10-09	Information Placard - Canopy Handle
3	1	D60-1133-10-19	Information Placard - Canopy Handle (old)

Diamond Aircraft Industries
WORK INSTRUCTION



Model DA 40 / DA 40 F / DA 40 D / DA 40 NG

Item	Quantity	Part Number	Description
4	1	D60-1133-20-60	Placard - Visual Indicator Passenger Door Handle
5	1	D60-1133-20-70	Placard - Visual Indicator Passenger Door Handle (old)

Consumables (if required)

Item	Quantity	Part Number	Description
6	A/R	Loctite 262	High-strength threadlocker adhesive
7	A/R	Loctite 243	Medium-strength threadlocker adhesive
7a	A/R	Loctite 241	Low-strength threadlocker adhesive
8	A/R	Vaseline	Petroleum jelly
9	A/R	ITW Plexus MA300	High-performance adhesive

Replacement Items (if required)

Hook Assembly (Safety Hook and Push Button)

Item	Quantity	Part Number	Description
10	1	DA4-5221-00-52_03	Safety hook
11	1	DA4-5221-00-32_02	Guide bush
12	1	DA4-5221-00-33_01	Locate bush
13	1	PAP 0505 P11	Collar bush
14	1	DIN 3771-7,66x1,78-FMP	O-ring
15	1	DA4-5221-00-31	Push button
16	1	VD_157	Pressure spring
17	1	RZ-059L	Tension spring

Retaining Block

Item	Quantity	Part Number	Description
18	1	DA4-5200-00-69_02	Retaining block
18a	1	DA4-5200-00-69_SB	Retaining block
19	2	DIN 965-M3x10-A2-BC	Screw, Phillips head countersunk

Diamond Aircraft Industries
WORK INSTRUCTION



Model DA 40 / DA 40 F / DA 40 D / DA 40 NG

Door Guide Block

Item	Quantity	Part Number	Description
20	1	DA4-5200-00-63	Guide block door, Front
21	1	DA4-5200-00-65	Guide block door, Rear
22	4	DIN 965-M5x20-A2	Screw, Phillips head countersunk

III INSPECTION AND MODIFICATION

1. Record any finding during the detailed inspections below in addition to the requested information on the execution report in Appendix A.
Store any removed parts for 6 months for possible further requests by Diamond Aircraft Industries Inc.
2. Check the canopy and passenger door warning-light as follows:

NOTE: Make sure that the front canopy and the passenger door are fully closed.
The operating handles must be flush against the canopy/door frame.

- Test the operation of the door unlocked warning light (DOOR OPEN or DOORS) on the PFD of G1000 or annunciator panel:
 - a) Set the ELECTRIC MASTER key switch to ON.
 - The warning light must be off.
 - b) Move the passenger door operating handle towards the open position.
 - The warning light must come on when the operating handle has moved away from the door frame.

NOTE: If the Garmin 1000 PFD does not display a “DOOR OPEN” warning or there is a delay in the alert of more than 5 seconds after the passenger door handle is fully open, remove the vent cover where the door alert micro-switches are located and check with a borescope for any interference.

- c) Move the door operating handle to the fully closed position.
 - The warning light must go off.
- d) Move the canopy operating handle towards the open position.
 - The warning light must come on when the operating handle has moved away from the door frame.

NOTE: If the Garmin 1000 PFD does not display a “DOOR OPEN” warning or there is a delay in the alert of more than 5 seconds after the passenger door handle is fully open, remove the vent cover where the door alert micro-switches are located and check with a borescope for any interference.

- e) Move the canopy operating handle to the fully closed position.
 - The warning light must go off.
 - f) Set the ELECTRICA MASTER key switch to OFF.
- In case of doubt, contact Diamond Aircraft Industries Inc.
 - Record any finding in the execution report in Appendix A.

3. Examine the carbon hinges of the passenger door. Refer to AMM Section 52-10.
 - Take notes and correct any findings after this WI is completed.
 - In case of doubt, contact Diamond Aircraft Industries Inc.
 - Record any finding in the execution report in Appendix A.
4. Identify the version of the safety hook (straight bottom or round bottom). Refer to Figure 1. Record the version on the execution report in Appendix A.

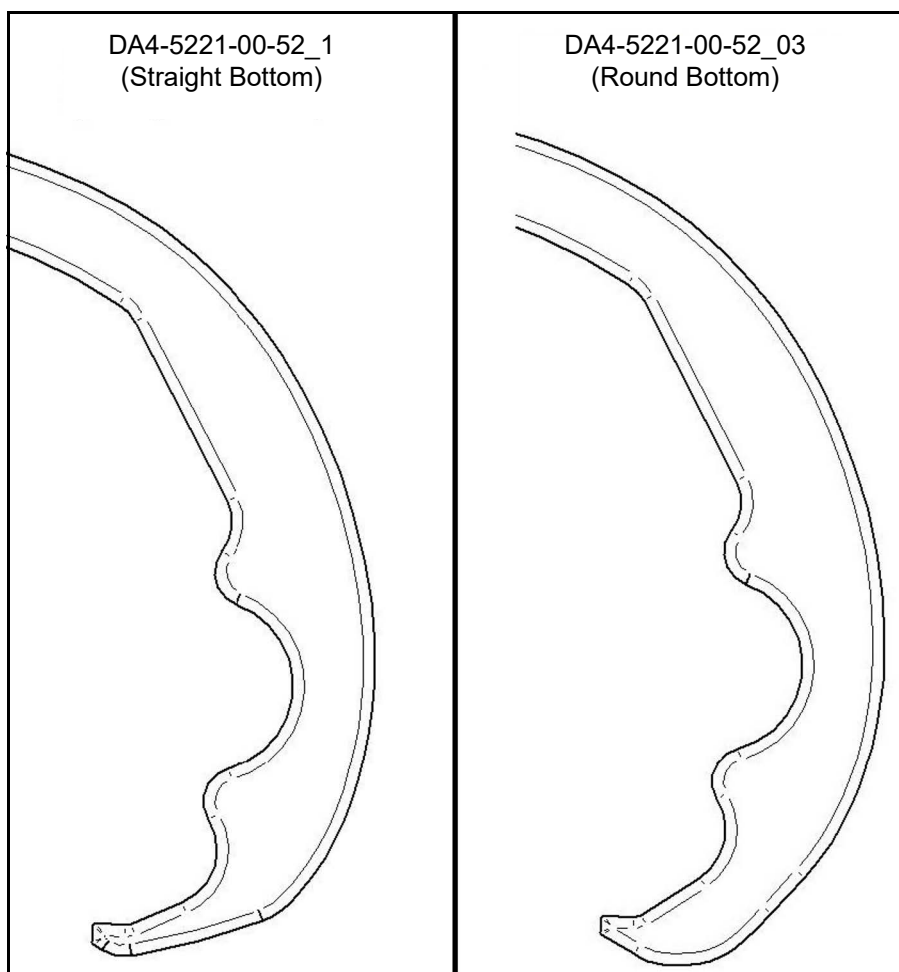

Figure 1.

5. Examine the safety hook for signs of wear, corrosion and poor condition:
Record the condition of the hook on the execution report in Appendix A.

NOTE: There must be no deformation or cracks.

- a) Check the contact area of the push button.
- Grooves in the safety hook must be less than 2 mm deep.



- b) Examine the hook end of the safety hook.

- The hook end must not be bent.

Not acceptable condition example:



- There must be no corrosion on the contact area of the safety hook.

Acceptable condition examples:

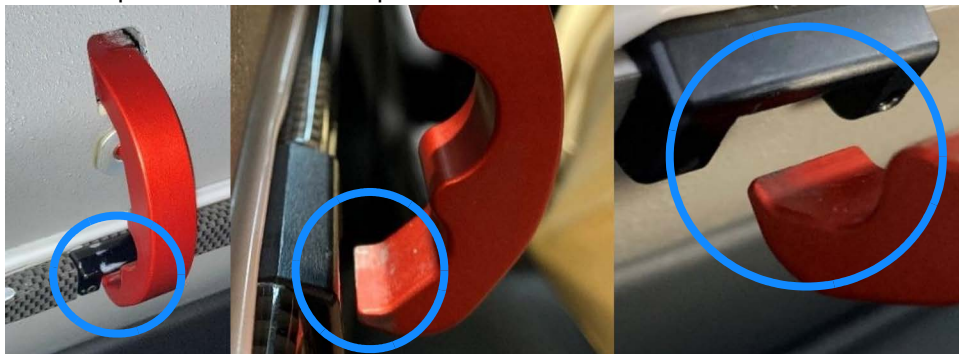

c) Examine the tip of the safety hook for wear:

- Wear of edges of safety hook.
- The width of the tip of the safety hook must be greater than 10.5mm.



d) Examine the engaging surface of the safety hook, which is the plane surface at the tip of the safety hook.

- It must not have any steps and ridges.
- Scratches or uniform wear of surface protection are acceptable.

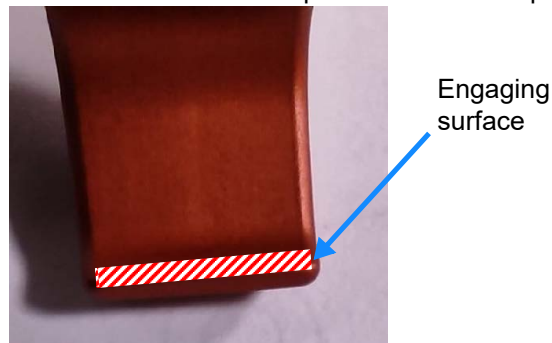

e) Measure the width of the engaging surface.

- The width must be greater than 1.5 mm.

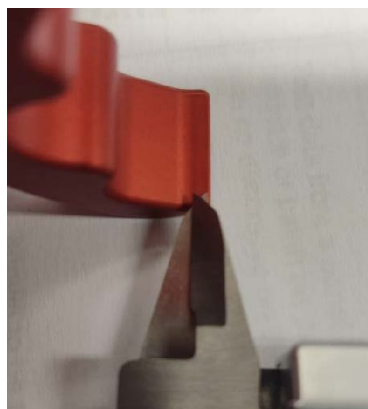

- f) Measure the maximum thickness of the safety hook at the location of the engaging surface, perpendicular to the engaging surface.
- The maximum thickness must be greater than 2.5 mm.
 - The the variation of thickness measured along the width of the safety hook must be less than 0.2 mm.

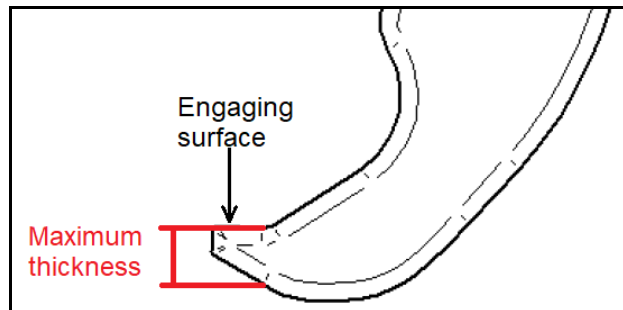

- g) Measure the minimum thickness of the safety hook at the location of the engaging surface, perpendicular to the engaging surface.
- The minimum thickness must be greater than 1.5 mm.
 - The variation of thickness measured along the width of the safety hook must be less than 0.2 mm.

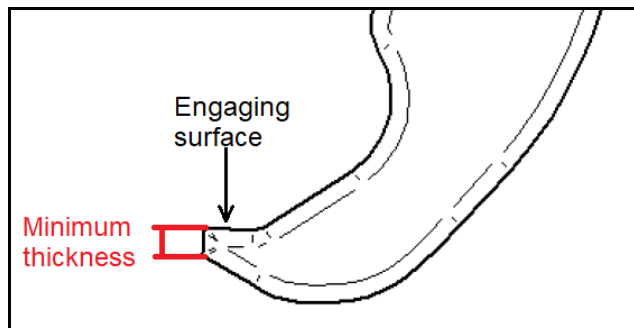

- The edge of the engaging surface of the safety hook that is facing towards the retaining block must not have any ridges.



- h) If the safety hook does not meet one or more of the acceptable conditions listed above on sub-steps **a** through **g**, take note to replace the safety hook after this WI is completed. Refer to Section IV for replacement of the safety hook.

6. Check the condition of the tension spring and the force to lift the safety hook from its resting position as follows:
Refer to Figure 2.
- a) Open the passenger door.
 - b) Examine the tension spring of the safety hook. Use a borescope through cutout in the door, if corrosion, deformation or damage is found, take note and replace it after this WI is completed. Refer to Section IV for removal and installation of the hook assembly.
 - c) Lift the safety hook and release it.
 - After releasing the force, the safety hook must snap back into its resting position.
 - If the safety hook does not snap back into its resting position, do the following:
 - 1) Check the attachment of the safety hook for increased friction.
 - 2) Check for interferences in the range of motion of the safety hook.
 - 3) Record findings on the execution report in Appendix A.
 - 4) If correction/replacement of any part is required, take notes and do it after this WI is completed. Refer to Section IV for removal and installation of the hook assembly.

NOTE: In case of doubt, contact Diamond Aircraft Industries Inc.

- d) Record the findings on the execution report in Appendix A.

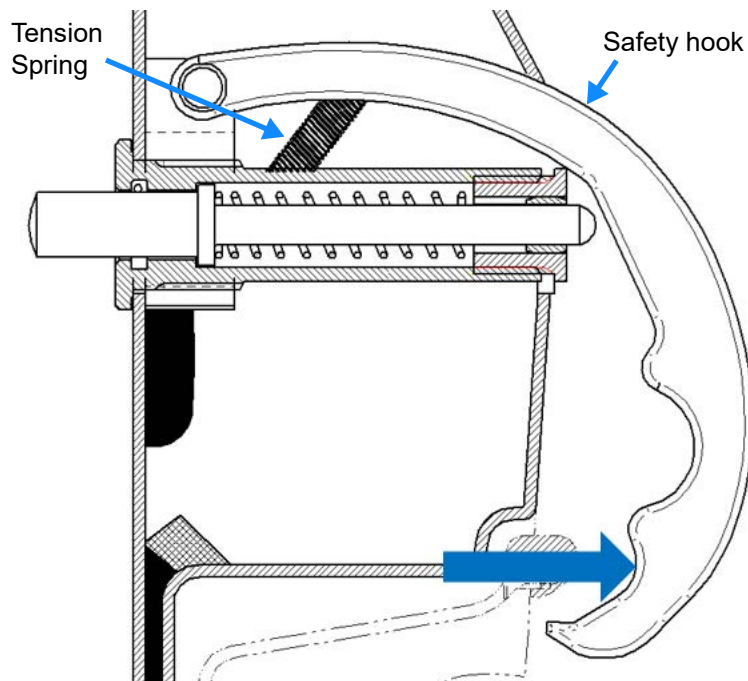
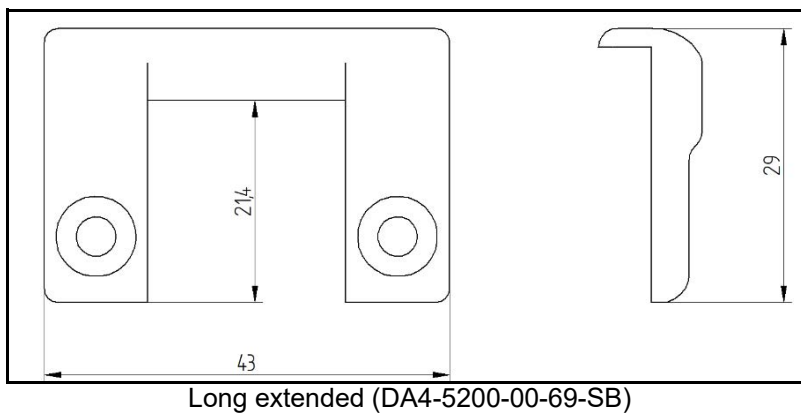
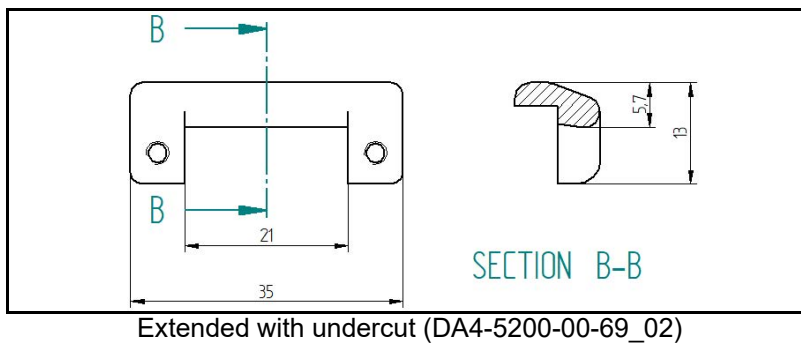
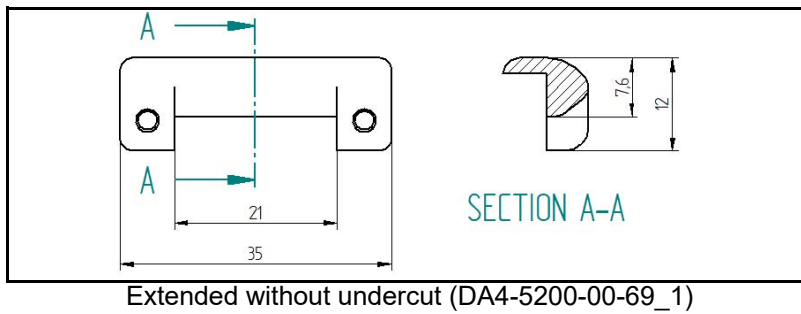
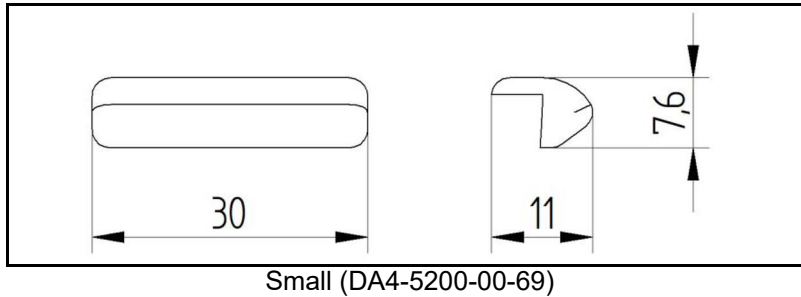
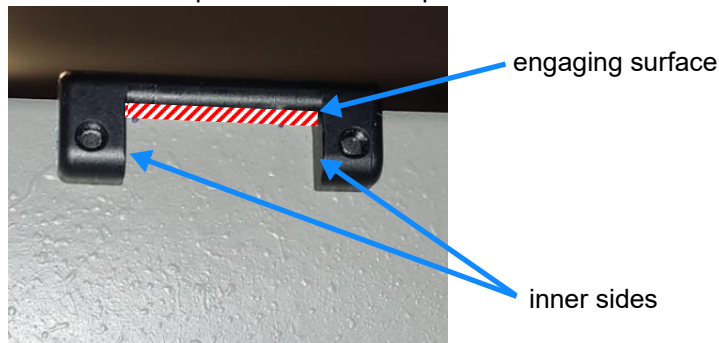

Figure 2.

7. Identify the version of the retaining block:
 Record the version in the execution report.



8. If retaining block DA4-5200-00-69 is installed (refer to step 7):
 - a) Replace the retaining block according to MSB40-070 / MSBD4-079 / MSBF4-024.
 - b) Record the replacement of the retaining block on the execution report in Appendix A.
9. Examine the retaining block for signs of wear, corrosion and poor condition.
 - There must be no corrosion on the retaining block.
 - Wear at the inner sides of the retaining block must be less than 0.5 mm per side.
 - The engaging surface of the retaining block and the edge of the engaging surface that is facing the retaining block must not have any steps and ridges.
 - Scratches or uniform wear of surface protection are acceptable.



- The thickness of the retaining block measured perpendicular to the upper surface must be greater than:
 - 4 mm for retaining block DA4-5200-00-69_02 (extended with undercut) or
 - 6 mm for all other retaining blocks. Refer to step 7 for retaining block versions.



- The width of the retaining block must be greater than 10 mm. Refer to Figure 3.
- The variation in thickness of the measured along the width of the retaining block must be less than 0.2 mm.



Figure 3.

If the retaining block does not meet one or more of the acceptable conditions mentioned in step 9, take notes and replace the retaining block after the WI is completed. Refer to section IV for removal/installation of the retaining block.

Record the condition of retaining block on the execution report in Appendix A.

10. Check if the safety hook remains engaged in the retaining block:

NOTE: The safety hook push button must not be pressed during this step.

- a) Close and latch the passenger door.
 - b) Unlatch the passenger door from the outside and pull on the outer passenger door handle.
 - The safety hook must engage with the retaining block and not disengage.
 - c) Pull on the outer passenger door handle with 15 ± 1 kg / 150 ± 10 N.
 - The safety hook must not disengage and must remain engaged in the retaining block.
 - d) Record the results in the execution report in Appendix A.
 - e) If the safety hook disengages, identify the cause, record it on the execution report in Appendix A and contact Diamond Aircraft Industries Inc.
11. Data collection: Measure the dimensions A, B,C, D and E as follows:
Refer to Figures 4 and 5.
- a) Close and latch the passenger door.

- b) Record the measurements on the execution report in Appendix A.
- Dimension A: distance of push button to the safety hook in resting position (e.g. with a feeler gauge). Refer to Figure 4.

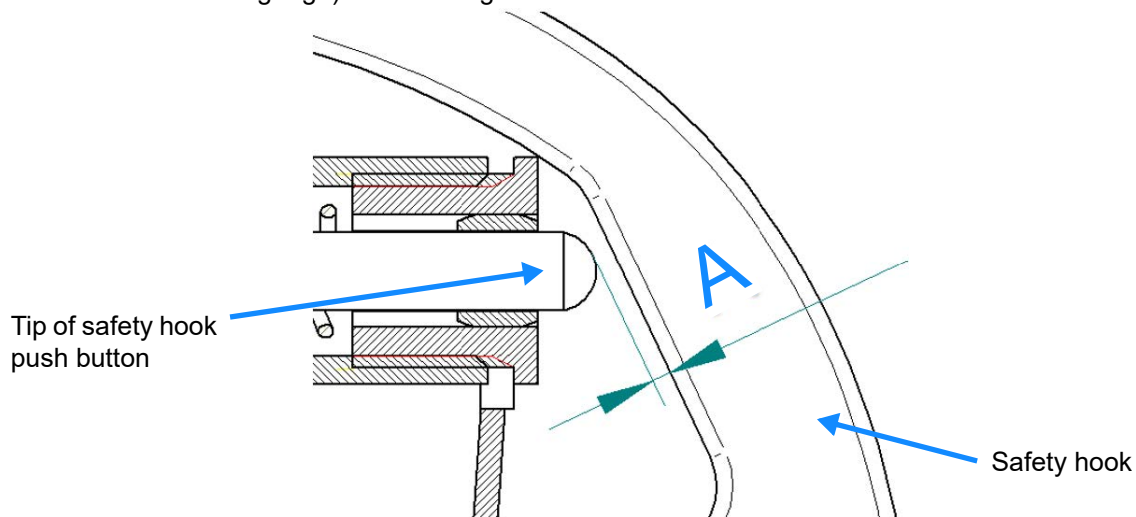

Figure 4.

- Dimension B: distance between the top surface of the retaining block to the top surface of the engaging section of the safety hook in resting position (e.g. with a ruler). Refer to Figure 5.
- Dimension C: horizontal distance between the tip of the safety hook and the fuselage wall (e.g. with a ruler). Refer to Figure 9.

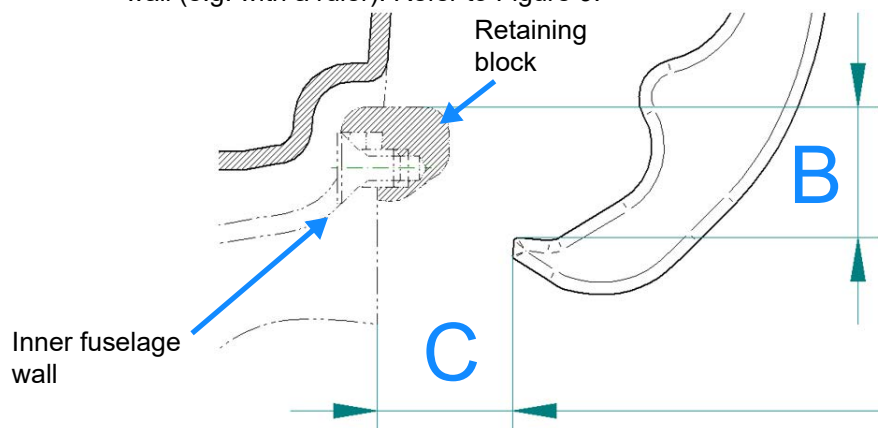

Figure 5.

- c) Unlatch the passenger door and push the passenger door open, engaging the safety hook into the retaining block. Apply slight pressure to the passenger door to keep the safety hook engaged during the measurement.
- d) Record the measurements on the execution report in Appendix A.

- Dimensions D and E (e.g. with a ruler). Refer to Figure 6.

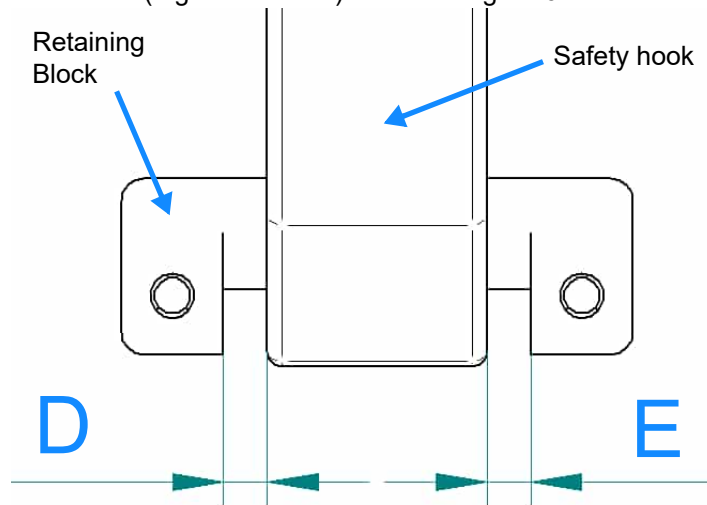

Figure 6.

12. Examine the safety hook push button for corrosion, wear and poor condition. Refer to Figure 7.

- There must be no corrosion on the sliding surfaces.
 - If corrosion is found, take note and replace corroded parts after the WI is completed. Refer to Section IV for removal and installation of the push button.
- The play of the push button in the bushing must be less than 1 mm.
 - If the play is greater than 1 mm, take note and replace the affected parts after the WI is completed. Refer to Section IV for removal and installation of the push button.
- Record any findings on the execution report in Appendix A.



Figure 7.

13. Examine for noticeable friction in the safety hook mechanism:
- a) Open the passenger door.
 - b) Lift the passenger door sufficiently to prevent any contact between the safety hook and the retaining block.
 - c) Push the safety hook push button.
 - The pin operation must be smooth. After release, the pin must snap into the initial position instantaneously (less than 1 second).
 - If the push button does not snap back into the initial position, lubricate the pin as per AMM Section 12-20 and repeat this step.
 - d) Move the passenger door to the fully closed position, but do not latch the door.
 - The safety hook must be in its resting position, when opening the door it must engage in the retaining block.
 - If the safety hook does not engage in the retaining block, repeat step 10.
 - e) Push the safety hook push button.
 - The safety hook must disengage, allowing the passenger door to be opened.
 - If the safety hook push button does not operate smoothly, isolate the problem:
 - Movement of the safety hook push button in its housing is not smooth and/or push button does not snap into initial position: lubricate as per AMM Section 12-20 and repeat this step. If the problem persists after lubrication, contact Diamond Aircraft Industries Inc. for additional instructions.
 - Friction in the hinge of the safety hook or chafing of the safety hook on the door structure.
Contact Diamond Aircraft Industries Inc. for additional instructions.
 - Friction between the safety hook push button and the safety hook: Polish the contact surface of the safety hook push button and the safety hook (respect the maximum permitted depth of the groove in the safety hook according to step 6) and repeat this examination.
 - f) Record the findings and any rectifications on the execution report in Appendix A.

14. Data collection: Identify the version of the passenger door latching mechanism. Refer to Figures 8 and 9.



Figure 8. Old door latching mechanism



Figure 9. New door latching mechanism (MÄM 40-139 Installed)

Record the version of the passenger door latching mechanism in the execution report.

15. If the old passenger door latch is installed (refer to step 14), visually inspect the spring:
Refer to Figure 10.
- a) Move the passenger door handle to the unlatched position.
 - b) Visually inspect the spring.
 - Look specifically for a broken winding, replace the spring if found broken.
 - c) Record any findings on the execution report in Appendix A.

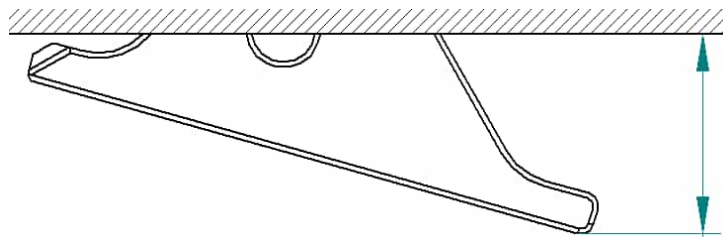

Figure 10.

16. Data collection: If MÄM 40-139 is installed (refer to step 14):
- Identify when the gas spring of the passenger door latching mechanism was last replaced/ installed.
 - Record the date of the last replacement on the execution report in Appendix A.
17. If MÄM 40-139 is installed (refer to step 14), examine the condition of the gas spring of the latching mechanism:
- Open the passenger door.
 - Move the door handle to unlatched position.
 - Slowly move the passenger door handle to latched position and measure the distance where the passenger door handle snaps into latched position by itself (measured at the outermost point of the lever, refer to sketch below).

CAUTION: Make sure that the latching bolts do not contact the fuselage surface.

- If the distance is less than 20 mm, take note to replace the compression gas spring after the WI is completed. Refer to AMM Section 52-10.
 - If the distance is less than 20 mm after replacement of the gas spring, the cause is high friction in the latching system.
 - Examine the latching bolts according to step 21.
 - If the reason for high friction in the latching system cannot be found, take note to replace the latching system after the WI is completed. Refer to AMM Section 52-10.
- Record the measured distance and any replacements on the execution report in Appendix A.



18. If MÄM 40-139 is installed (refer to step 14), examine the adjustment of the gas spring in the passenger door latching mechanism.
- The gas spring inside the door handle must push the door handle into the latched position firmly against the stop:
 - a) Open the passenger door.
 - b) Move the passenger door handle to the latched position.
 - c) Examine if the door handle is pushed into the mechanical stop inside the door handle mechanism (marked in the pictures below).
 - d) If the passenger door handle is not pushed against the mechanical stop by the gas spring, adjust the gas spring (refer to AMM section 52-10) and repeat this step.
 - e) Record if the gas spring was adjusted properly on the execution report in Appendix A.



19. Data collection: Position of the external passenger door handle. Refer to Figures 11 and 12.
- Close the passenger door.
 - Push the external passenger door handle into the latched position until it stops.
 - Examine if the passenger door handle is recessed, flush or protruding over the passenger door surface.
 - Record the condition of the passenger door handle on the execution report in Appendix A.
 - If the handle protrudes from the surface of the passenger door, measure the protrusion.
 - Record the measurement on the execution report in Appendix A.

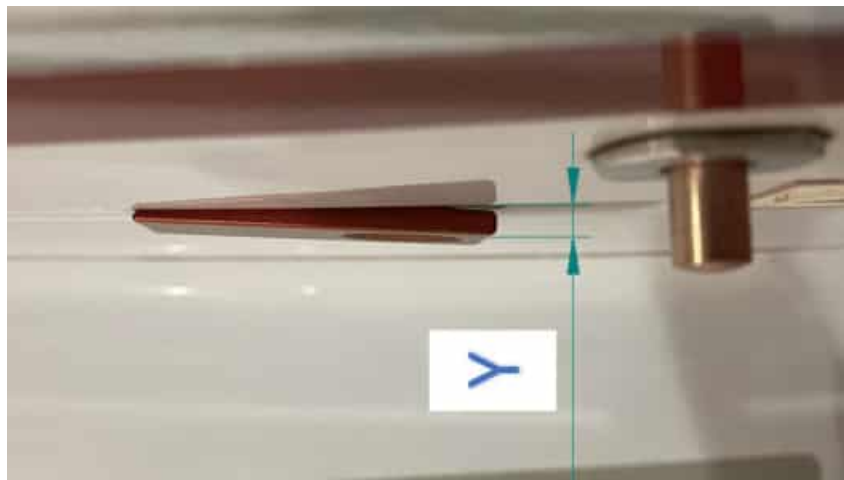

Figure 11. Protrusion measurement



Figure 12. Recessed passenger door handle example

20. Measure the passenger door handle actuation force:

- a) **Close** and latch the passenger door.
- b) Attach a spring scale with suitable measurement range to the external passenger door handle. Refer to Figure 13.
- c) Measure the force necessary to unlatch the passenger door.
 - The force must be **less** than 6 kg / 60 N.
 - If the force is greater than 6 kg / 60 N:
 - Identify the reason for exceeding the maximum force limit and rectify any findings.
- d) **Open** the passenger door.
- e) Move the passenger door handle to the latched position.

CAUTION: Make sure that the latching bolts do not contact the fuselage surface.

- f) Measure the force necessary to move the passenger door handle to the unlatched position.
 - The force must be **greater** than 1.8 kg / 18 N.
 - If the force is less than 1.8 kg / 18 N:
 - Identify the reason for not reaching the minimum force limit and rectify any findings.
 - Record the measured forces and any findings on the execution report in Appendix A.



Figure 13. Force measurement example

21. Examine the latching bolts of the passenger door for looseness, excessive play, wear, corrosion and poor condition. Refer to Figure 14.
- It must not be possible to rotate the latching bolts by hand force.
 - The radial play (side-to-side) of the latching bolts must be less than 0.8 mm at the tip of the latching bolts.
 - If the radial play is greater than 0.8 mm, contact Diamond Aircraft Industries Inc.
 - No signs of corrosion is allowed.
 - If you find signs of corrosion on the latching bolts, take note and replace the latching bolts after the WI is completed. Refer to AMM 52-10 for replacement.
 - No deformation (dents, bends, cracks) on the latching bolts is allowed.
 - If deformations of the latching bolts are found, take note and replace the latching bolts after the WI is completed. Refer to AMM 52-10 for replacement
 - In case of doubt, contact DAI for instructions.
 - Record any findings on the execution report in Appendix A.



Figure 14. Example of serviceable latching bolt

22. Measure the extension length of the latching bolts of the passenger door.

- a) Unlatch and open the passenger door.
- b) Move the passenger door latching mechanism to the latched position.

CAUTION: Make sure that the latching bolts do not contact the fuselage surface.

- c) Measure the extension length at the bottom of the front and rear latching bolts in mm. Refer to Figures 15 and 16.
 - The front latching bolt extension length must be 40 ± 1 mm.
 - If the extension length is out of tolerance, adjust the latching bolt if possible, or take note to replace latching bolt (if necessary) after the WI is completed. Refer to AMM section 52-10.
 - If you adjusted the latching bolt, repeat this step.

NOTE: If MÄM 40-619 is **not** installed, the rear latching bolt extension length must be 40 ± 2 mm.

- If the extension length is out of tolerance, or take note to replace latching bolt (if necessary) after the WI is completed. Refer to AMM section 52-10.
- If you adjusted the latching bolt, repeat this step.

NOTE: If MÄM 40-619 is installed, the rear latching bolt extension length must be 44 ± 1 mm.

- If the extension length is out of tolerance, adjust the latching bolt if possible, or take note to replace latching bolt (if necessary) after the WI is completed. Refer to AMM section 52-10.
- If you adjusted the latching bolt, repeat this step.

- d) Record the measurements and any findings on the execution report in Appendix A.



Figure 15. Front latching bolt



Figure 16. Rear latching bolt

NOTE: Aid for identification: There is a metal plate bolted to the lower surface of the passenger door if MÄM 40-619 is installed. Refer to Figure 17.

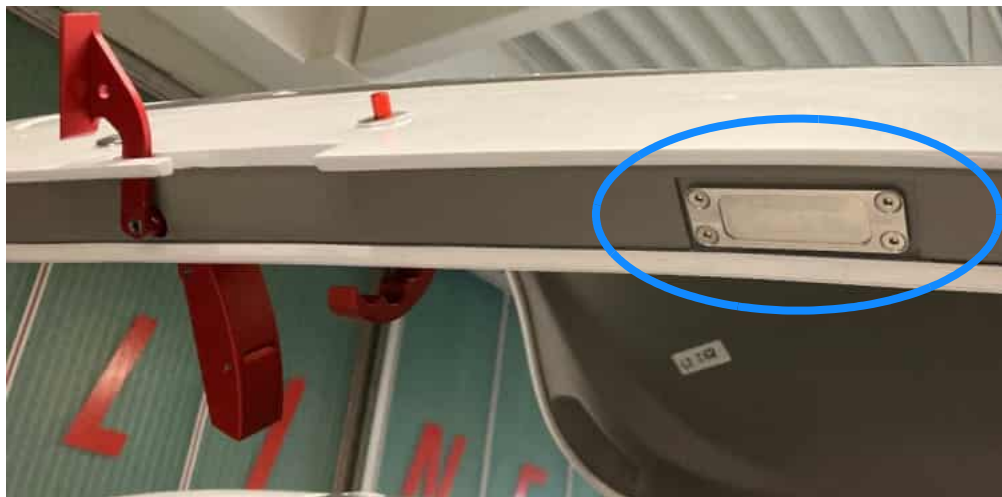

Figure 17. Metal plate

23. Inspect the front and rear door guide block for damage. Refer to Figure 18.

- a) Open the passenger door.
- b) Visually check the condition of the guide block.
 - The guide block must not have worn edges, dents, cracks.
 - If you found any damage, take note and replace the guide block after the WI is completed. Refer to section IV for the replacement.
 - Record any damage of the guide blocks on the execution report in Appendix A.

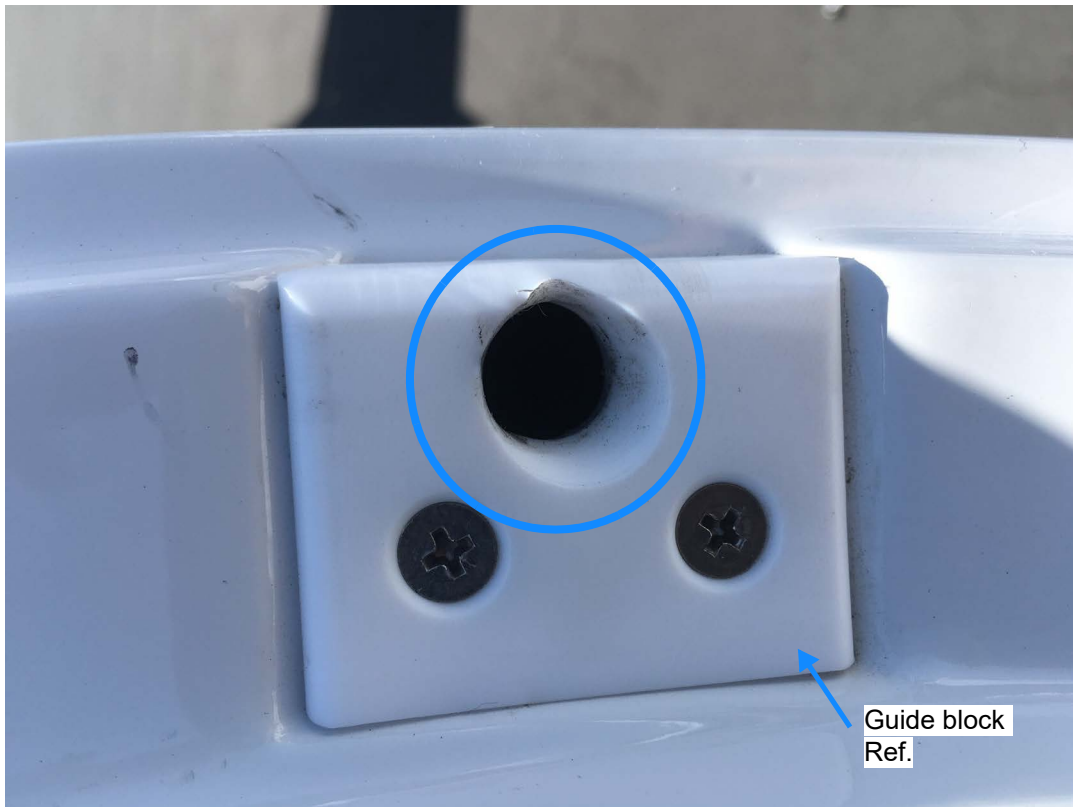

Figure 18. Example of **NOT** acceptable condition of door guide block

24. Data collection: Inspect the door frame in the area around the front and rear latching bolts for damage. Refer to Figures 19 and 20.

Record any damage on the execution report in Appendix A.



Figure 19. Front



Figure 20. Rear

25. Examine the aircraft log, if RSB 40-083 / RSB D4-105 / RSB 40NG-053 was performed.
Record if the RSB was performed on the execution report in Appendix A.
26. Insert AFM-TR-MÄM 40-1203, latest revision, into the AFM or use an AFM revision that has this temporary revision incorporated.
27. Insert AMM-TR-MÄM 40-1203, latest revision, into the AMM or use an AMM revision that has this temporary revision incorporated.
28. If MÄM 40-139 is installed (new door latching mechanism, refer to step 14), install placard (item 2) to the upper side of the inner canopy handle. Refer to Figure 21.
 - a) Unlatch the canopy.
 - b) Clean the canopy handle from dirt and grease.

- c) Align the placard with the straight edge and position it in spanwise direction so that it is completely visible from the pilot's perspective if the canopy handle is in the unlatched position.
- d) The placard must disappear when the canopy handle is in the latched position. Refer to Figure 22.



Figure 21.



Figure 22.

29. If MÄM 40-139 is not installed (old latching mechanism, refer to step 14), install placard (item 3) to the upper side of the inner canopy handle. Refer to Figure 23.
- Unlatch the canopy.
 - Clean the canopy handle from dirt and grease.
 - Align the placard so that the straight edge (indicated by the blue arrows) disappears behind the edge of the door frame (indicated by the yellow arrows), seen from the pilot's perspective with the canopy handle is in the latched position.
 - The placard must disappear when the canopy handle is in the latched position. Refer to Figure 24.
 - The placard must be completely visible from the pilot's perspective if the canopy handle is in the unlatched position. Refer to Figure 23.



Figure 23.



Figure 24.

30. Install placard (item 1) to the passenger door. Refer to Figures 25 and 26.
- a) Clean the area where the placard will be attached from dirt and grease.
 - b) Position the placard approximately 10 mm forward of the safety hook cut-out in the passenger door and approximately 10 mm above the passenger door handle.



Figure 25. New latching mechanism (MÄM 40-139 installed)



Figure 26. Old latching mechanism (MÄM 40-139 not installed)

31. If MÄM 40-139 is installed (new latching mechanism, refer to step 14), install placard (item 4) on the top surface of the inner passenger door handle. Refer to Figure 27.
- Clean the inner passenger door handle from dirt and grease.
 - Close and latch the passenger door.
 - Mark the line on the passenger door handle where it is visible when observed from the pilot's perspective over the LH shoulder.
 - Unlatch the passenger door.
 - Align the placard with the marked line.
 - Trim the placard on the edges of the passenger door handle, if necessary.
- The placard must completely disappear with the passenger door latched when observed from the pilot's perspective over the LH shoulder. Refer to Figure 27, latch closed.



Latch open



Latch closed

Figure 27.

32. If MÄM 40-139 is not installed (old latching mechanism, refer to step 14), install placard (item 5) on the top surface of the inner passenger handle. Refer to Figure 28.
- Clean the inner passenger door handle from dirt and grease.
 - Close and latch the passenger door.
 - Mark the line on the passenger door handle where it is visible when observed from the pilot's perspective over the LH shoulder.
 - Unlatch the passenger door.
 - Align the placard with the marked line.
 - Trim the placard on the edges of the passenger door handle, if necessary.
- The placard must completely disappear with the passenger door latched when observed from the pilot's perspective over the LH shoulder. Refer to Figure 28, latch closed.



Latch open



Latch closed

Figure 28.

33. Clean the working areas, check for foreign objects.
34. Check all altered, replaced, repaired parts for proper function.

35. Test all systems in the working area for function.
36. Do all necessary entries in the airplane logs.
37. Store any removed parts for 6 months for possible further requests by Diamond Aircraft Industries Inc.
38. Submit the execution report in Appendix A to Diamond Aircraft Industries Inc.
 - Use the electronic execution report through the Diamond Partner Portal at <https://partners.diamondaircraft.com/>
 - Alternatively send the execution report by email to techpubs@diamondaircraft.com
 - Keep a copy of the execution report in the aircraft log.

IV REPLACEMENT PROCEDURES (IF REQUIRED)

IV.1 Hook assembly (Safety Hook and Push Button)

Refer to Figure 29.

NOTE: To replace the safety hook or push button, the hook assembly (safety hook and push button) needs to be removed from the airplane and taken to a work table for disassembly.

NOTE: Before you remove the hook assembly, complete step 12. The following steps can be used to replace parts of the push button, if necessary.

1. Remove the inner door handle to get access to the inside of the door. Refer to AMM Section 52-10.
2. Unscrew the guide bush and locate bush to release the push button assembly.

NOTE: Remove existing sealant as required.

3. Remove the hook assembly from aircraft through the handle opening and place it on a work table to replace safety hook.
4. Remove screw that secures the tension spring on the safety hook.
5. Remove cotter pin to release safety hook, pin and washers.
6. Install the new safety hook (item 10) using the pin, washers and cotter pin.
7. Reinstall tension spring using the screw to secure it. Use Loctite 262 (item 6) to screw, refer to manufacturer instructions for proper use.

NOTE: Make sure reused parts are in serviceable condition before you reinstall them.

8. Replace any defective parts of the push button.
9. Reinstall hook assembly to the aircraft door:
 - a) Route the hook assembly through the handle opening and secure to outside door shell with guide bush (item 11).
 - b) Insert collar bush (item 13) into locate bush (item 12).
 - c) Apply a small amount of Vaseline (item 8) to o-ring (item 14) and insert into guide bush.
 - d) Insert push button (item 15) and pressure spring (item 16) into guide bush (item 11) and screw guide bush and locate bush (item 12) together.
 - e) Apply ITW Plexus MA300 (item 9) or thickened resin (5 min epoxy + cotton flakes) to the bearing block on the inside of the door. Refer to Figure 30 and the manufacturer instructions for proper use.
10. Record the replacement on the execution report in Appendix A.

NOTE: In case of doubt, contact Diamond Aircraft Industries Inc.

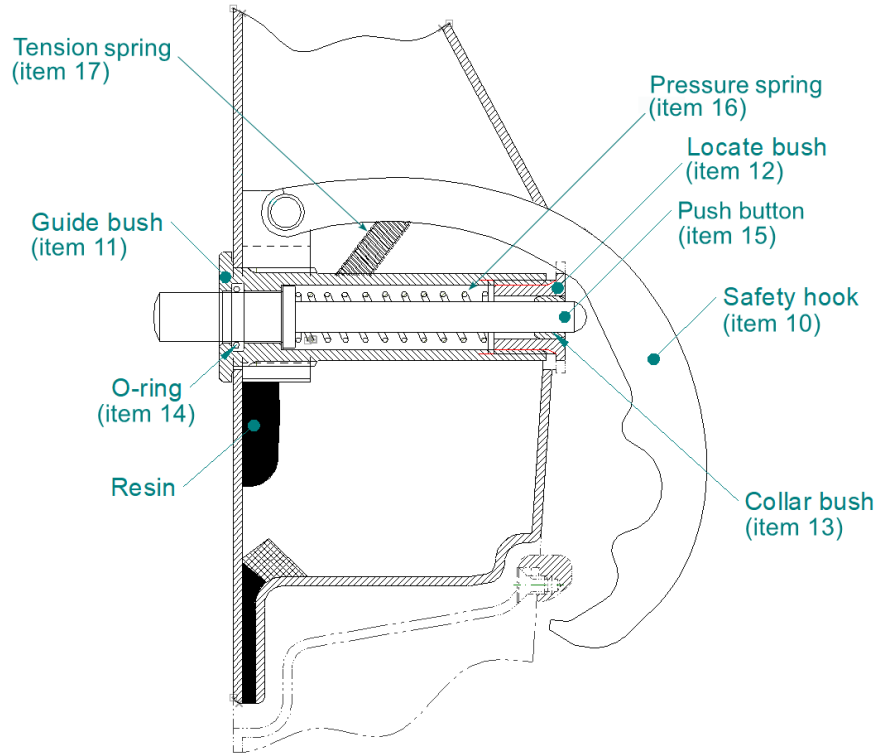

Figure 29.

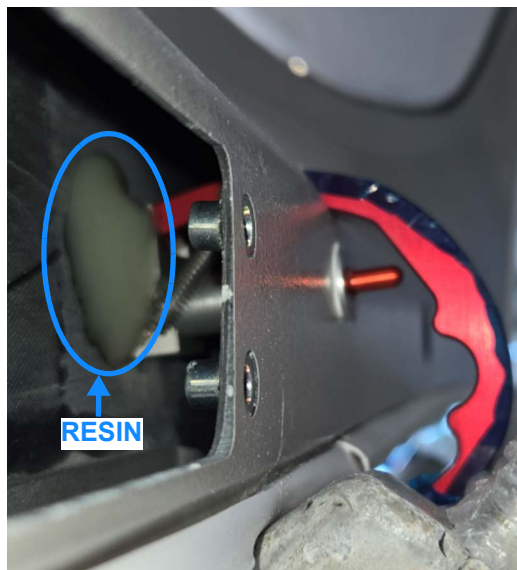

Figure 30.

VI.2 Retaining Block

NOTE: If you are replacing DA4-5200-00-69_01, use DA4-5200-00-69_02.
If you are replacing DA4-5200-00-69_02, use the same part (DA4-5200-00-69_02).
If you are replacing DA4-5200-00-69_SB, use the same part (DA4-5200-00-69_SB).

1. Remove existing retaining block and 2 screws.
2. Install new retaining block (item 18 or 18a) using two screws (item 19). Apply threadlocker Loctite 241 or 243 (item 7 or 7a) to screws before installation, refer to manufacturer instructions for proper use.

NOTE: Use new screws or make sure the existing screws are in serviceable condition and cleaned before you apply threadlocker and reinstall them.

3. Record the replacement of the retaining block on the execution report in Appendix A.

VI.3 Door Guide Block

1. Remove the 2 screws that attach the guide block and remove it from aircraft.
2. Install new guide block (item 20 and/or 21) with 2 screws (item 22). Use Loctite 241 or 243 (item 7 or 7a) to screw, refer to manufacturer instructions for proper use.

NOTE: Use new screws or make sure the existing screws are in serviceable condition and cleaned before you apply threadlocker and reinstall them.

3. Record the replacement of the guide blocks on the execution report in Appendix A.

APPENDIX A
EXECUTION REPORT TO
SERVICE BULLETIN
WI-MSB 40-103 / WI-MSB F4-042 /
WI-MSB D4-114 / WI-MSB 40NG-084

AIRPLANE DATA

Airplane serial number _____
Airplane registration _____
Airplane operator _____
Hours of operation of airplane (TSN) _____
Typical operation of airplane private, club, training, other: _____

MAINTENANCE DATA

Date of maintenance _____
Maintenance carried out by _____
During scheduled inspection? Yes No

Name	Signature	Date
------	-----------	------

Submit the execution report in Appendix A to Diamond Aircraft Industries Inc. as follows:

1. Use the electronic execution report through the Diamond Partner Portal.
 - a) Login to the Diamond Partner Portal: <https://partners.diamondaircraft.com/>
 - b) Search for the Aircraft (A/C):
 - Use the search field at the top, or
 - Navigate through the menu: Support > My fleet, then open the A/C by clicking the link.
 - c) In the right section "Aircraft Action", click the button "Add Execution Report".
 - d) Choose "MSB 40-103 / MSB F4-042 / MSB D4-114 / MSB 40NG-084".
 - e) Either create a new execution report or select a draft you previously created.
 - f) Save and then submit the execution report.

2. Alternatively send the execution report by email to techpubs@diamondaircraft.com

Keep a copy of the execution report in the aircraft log.

Diamond Aircraft Industries
WORK INSTRUCTION



Model DA 40 / DA 40 F / DA 40 D / DA 40 NG

EXECUTION REPORT WI-MSB 40-103 / WI-MSB F4-042 / WI-MSB D4-114 / WI-MSB 40NG-084		
Step	Reported information	Answer
Step 2	Record any findings in the "Additional Findings" field.	
Step 3	Record any findings in the "Additional Findings" field.	
Step 4	Installed version of safety hook:	
	DA4-5221-00-52_1 (straight bottom)	<input type="radio"/>
	DA4-5221-00-52_03 (round bottom)	<input type="radio"/>
Step 5	Is replacement of safety hook required after WI?	<input type="radio"/> Yes / <input type="radio"/> No
	Record any findings in the "Additional Findings" field.	
Step 6	Force to lift the safety hook (in kg or N) as found on aircraft.	
	Force to lift the safety hook (in kg or N) after the replacement of tension spring (if required)	
	Did the safety hook snap back into its resting position?	<input type="radio"/> Yes / <input type="radio"/> No
	Record any findings in the "Additional Findings" field.	
Step 7	Identify which retaining block version is installed:	
	DA4-5200-00-69 (small)	<input type="radio"/>
	DA4-5200-00-69_1 (extended without undercut)	<input type="radio"/>
	DA4-5200-00-69_02 (extended with undercut)	<input type="radio"/>
	DA4-5200-00-69-SB (long extended for retrofit)	<input type="radio"/>
Step 8	Was the retaining block replaced?	<input type="radio"/> Yes / <input type="radio"/> No
Step 9	Is replacement of retaining block required after WI?	<input type="radio"/> Yes / <input type="radio"/> No
	Record any findings in the "Additional Findings" field.	
Step 10	Did the safety hook engage in the retaining block?	<input type="radio"/> Yes / <input type="radio"/> No
	Did the safety hook disengage?	<input type="radio"/> Yes / <input type="radio"/> No
	If the safety hook disengaged: Cause isolated and identified as:	
	Record any findings in the "Additional Findings" field.	

Diamond Aircraft Industries
WORK INSTRUCTION



Model DA 40 / DA 40 F / DA 40 D / DA 40 NG

EXECUTION REPORT WI-MSB 40-103 / WI-MSB F4-042 / WI-MSB D4-114 / WI-MSB 40NG-084		
Step	Reported information	Answer
Step 11	Record the measured dimensions (in mm)	
		A
		B
		C
		D
		E
Step 12	Is replacement of safety hook required after WI?	<input type="radio"/> Yes / <input type="radio"/> No
	Record any findings in the "Additional Findings" field.	
Step 13	Push button	
	The push button is in acceptable condition.	<input type="radio"/> Yes / <input type="radio"/> No
	The push button is damaged	<input type="radio"/>
	Operation not smooth	<input type="radio"/>
	The pressure spring is broken	<input type="radio"/>
	O-Ring failed	<input type="radio"/>
	Pin housing is damaged	<input type="radio"/>
	Pin housing thread connection is loose	<input type="radio"/>
	Pin bushing is worn	<input type="radio"/>
	Smooth operation	<input type="radio"/>
	Rough operation	<input type="radio"/>
		Record any findings in the "Additional Findings" field.
Step 14	Which version of door latching mechanism is installed?	
	Old design	<input type="radio"/>
	New design (MÄM 40-139)	<input type="radio"/>
Step 15	Record any findings in the "Additional Findings" field.	
Step 16	If MÄM 40-139 is installed: What is the date of the last passenger door gas spring replacement	MM/YYYY

Diamond Aircraft Industries
WORK INSTRUCTION



Model DA 40 / DA 40 F / DA 40 D / DA 40 NG

EXECUTION REPORT WI-MSB 40-103 / WI-MSB F4-042 / WI-MSB D4-114 / WI-MSB 40NG-084		
Step	Reported information	Answer
Step 17	Gas spring function	/
	Distance to automatically close (in mm)	
	If the gas spring is replaced: Distance to automatically close (in mm) after gas spring replacement	
	Record any findings in the "Additional Findings" field.	
Step 18	Was the gas spring adjusted properly?	<input type="radio"/> Yes / <input type="radio"/> No
Step 19	Position of the outside passenger door handle	<input type="radio"/> Protrusion <input type="radio"/> Flush <input type="radio"/> Recessed
	Protrusion Y (in mm)	
Step 20	Door handle actuation force (in kg or N)	/
	Closed passenger door as found on aircraft	
	Closed passenger door after the rectification (if required)	
	Open passenger door as found on aircraft	
	Open passenger door after the rectification (if required)	
Step 21	Is replacement of latching bolts required after WI?	<input type="radio"/> Yes / <input type="radio"/> No
	Record any findings in the "Additional Findings" field.	/
Step 22	Is replacement of latching bolts required after WI?	
	Latching bolt extension length (in mm) as found on aircraft	/
	Front (40 ± 1 mm)	
	Rear (40 ± 2 mm, if MÄM 40-619 is not installed) (44 ± 1 mm, if MÄM 40-619 is installed)	
	Record any findings in the "Additional Findings" field.	/
Step 23	Is replacement of guide blocks required after WI?	
Step 24	Record any findings in the "Additional Findings" field.	/
	Step 25	

Additional Findings (Append additional pages if necessary)

Diamond Aircraft Industries
WORK INSTRUCTION

Model DA 40 / DA 40 F / DA 40 D / DA 40 NG



To obtain satisfactory results, procedures specified in this service bulletin must be accomplished in accordance with accepted methods and current government regulations. Diamond Aircraft cannot be responsible for the quality of work performed in accomplishing the requirements of this service bulletin. Diamond Aircraft reserves the right to void continued warranty coverage in the area affected by this service bulletin if it is not incorporated.

If you no longer own the aircraft to which this service bulletin applies, please forward it to the current owner, and send the name of the current owner to Diamond Aircraft at the address below.

Diamond Aircraft Industries Inc.
1560 Crumlin Sideroad, London, Ontario, Canada
N5V 1S2

Customer Support:
Phone: (519) 457-4041, Fax: (519) 457-4045
Portal: partners.diamondaircraft.com