



**JAR-VLA
FLIGHT MANUAL**

Katana

DA 20/100

Category of Airworthiness : NORMAL
Applicable Airworthiness Requirements :JAR VLA incl. Amendment VLA/92/1
Serial No. :
Registration :
Date of Issue : 20 December, 2000
Document No. : DA202-100-VLA

This manual must be carried in the aircraft at all times! Scope and revision status can be found in the List of Effective Pages and in the Record of Revisions.

The pages identified as "DOT-appr." in the List of Effective Pages are approved by:

Signature William Jupp
Authority Chief, Flight test
For Director, Aircraft Certification
Transport Canada
Date of approval 20 December, 2000

This airplane is to be operated in compliance with the information and limitations contained herein.

PREFACE

Congratulations on your choice of the DA 20/100 KATANA.

Safe handling of an airplane increases and ensures your safety and provides you with many hours of enjoyment. For this reason you should take the time to familiarize yourself with your KATANA airplane.

We ask that you carefully read this Flight Manual and pay special attention to the recommendations given. A careful study of the manual will reward you with many hours of trouble-free flight operation of your KATANA airplane.

All rights reserved. Reproduction of this manual or any portion thereof by any means without the express written permission of DIAMOND AIRCRAFT INDUSTRIES prohibited.

Copyright © by DIAMOND AIRCRAFT INDUSTRIES,
London, Ontario
Canada

TABLE OF CONTENTS

	Chapter
GENERAL	1
OPERATING LIMITATIONS	2
EMERGENCY PROCEDURES	3
NORMAL OPERATING PROCEDURES	4
PERFORMANCE	5
WEIGHT AND BALANCE / EQUIPMENT LIST	6
DESCRIPTION OF THE AIRPLANE AND ITS SYSTEMS	7
HANDLING, PREVENTIVE AND CORRECTIVE MAINTENANCE	8
SUPPLEMENTS	9

LIST OF EFFECTIVE PAGES

Chapter	Page	Date	Chapter	Page	Date
0	0-1	January 18, 2012	3	DOT-appr 3-1	January 18, 2012
	0-2	January 18, 2012		DOT-appr 3-2	January 18, 2012
	0-3	January 18, 2012		DOT-appr 3-3	January 18, 2012
	0-4	January 18, 2012		DOT-appr 3-4	January 18, 2012
	0-5	January 18, 2012		DOT-appr 3-5	January 18, 2012
	0-6	January 18, 2012		DOT-appr 3-6	January 18, 2012
	0-7	January 18, 2012		DOT-appr 3-7	January 18, 2012
	0-8	January 18, 2012		DOT-appr 3-8	January 18, 2012
	0-9	January 18, 2012		DOT-appr 3-9	January 18, 2012
	0-10	January 18, 2012		DOT-appr 3-10	January 18, 2012
1	1-1	January 18, 2012		DOT-appr 3-11	January 18, 2012
	1-2	January 18, 2012		DOT-appr 3-12	January 18, 2012
	1-3	January 18, 2012		DOT-appr 3-13	January 18, 2012
	1-4	January 18, 2012		DOT-appr 3-14	January 18, 2012
	1-5	January 18, 2012		DOT-appr 3-15	January 18, 2012
	1-6	January 18, 2012		DOT-appr 3-16	January 18, 2012
	1-7	January 18, 2012		DOT-appr 3-17	January 18, 2012
	1-8	January 18, 2012		DOT-appr 3-18	January 18, 2012
	1-9	January 18, 2012	4	DOT-appr 4-1	January 18, 2012
	1-10	January 18, 2012		DOT-appr 4-2	January 18, 2012
	1-11	January 18, 2012		DOT-appr 4-3	January 18, 2012
	1-12	January 18, 2012		DOT-appr 4-4	January 18, 2012
	1-13	January 18, 2012		DOT-appr 4-5	January 18, 2012
1-14	January 18, 2012	DOT-appr 4-6		January 18, 2012	
2	DOT-appr. 2-1	January 18, 2012	DOT-appr 4-7	January 18, 2012	
	DOT-appr. 2-2	January 18, 2012	DOT-appr 4-8	January 18, 2012	
	DOT-appr. 2-3	January 18, 2012	DOT-appr 4-9	January 18, 2012	
	DOT-appr 2-4	January 18, 2012	DOT-appr 4-10	January 18, 2012	
	DOT-appr. 2-5	January 18, 2012	DOT-appr 4-11	January 18, 2012	
	DOT-appr. 2-6	January 18, 2012	DOT-appr 4-12	January 18, 2012	
	DOT-appr. 2-7	January 18, 2012	DOT-appr 4-13	January 18, 2012	
	DOT-appr. 2-8	January 18, 2012	DOT-appr 4-14	January 18, 2012	
	DOT-appr. 2-9	January 18, 2012	DOT-appr 4-15	January 18, 2012	
	DOT-appr. 2-10	January 18, 2012	DOT-appr 4-16	January 18, 2012	
	DOT-appr. 2-11	January 18, 2012	DOT-appr 4-17	January 18, 2012	
	DOT-appr. 2-12	January 18, 2012			
	DOT-appr. 2-13	January 18, 2012			
	DOT-appr. 2-14	January 18, 2012			
	DOT-appr 2-15	January 18, 2012			
	DOT-appr 2-16	January 18, 2012			
	DOT-appr. 2-17	January 18, 2012			

Chapter	Page	Date	Chapter	Page	Date	
5	DOT-appr 5-1	January 18, 2012	7	7-1	January 18, 2012	
	DOT-appr 5-2	January 18, 2012		7-3	January 18, 2012	
	DOT-appr 5-3	January 18, 2012		7-4	January 18, 2012	
	DOT-appr 5-4	January 18, 2012		7-5	January 18, 2012	
	DOT-appr 5-5	January 18, 2012		7-6	January 18, 2012	
	DOT-appr 5-6	January 18, 2012		7-7	January 18, 2012	
	DOT-appr 5-7	January 18, 2012		7-8	January 18, 2012	
	DOT-appr 5-8	January 18, 2012		7-9	January 18, 2012	
	DOT-appr 5-9	January 18, 2012		7-10	January 18, 2012	
	DOT-appr 5-10	January 18, 2012		7-11	January 18, 2012	
	DOT-appr 5-11	January 18, 2012		7-12	January 18, 2012	
	DOT-appr 5-12	January 18, 2012		7-13	January 18, 2012	
	DOT-appr 5-13	January 18, 2012		7-14	January 18, 2012	
	DOT-appr 5-14	January 18, 2012		7-15	January 18, 2012	
	DOT-appr 5-15	January 18, 2012		7-16	January 18, 2012	
6	DOT-appr. 6-1	January 18, 2012	8	7-17	January 18, 2012	
	DOT-appr 6-2	January 18, 2012		7-18	January 18, 2012	
	DOT-appr 6-3	January 18, 2012		8-1	January 18, 2012	
	DOT-appr 6-4	January 18, 2012		8-2	January 18, 2012	
	DOT-appr 6-5	January 18, 2012		8-3	January 18, 2012	
	DOT-appr 6-6	January 18, 2012		8-4	January 18, 2012	
	DOT-appr 6-7	January 18, 2012		8-5	January 18, 2012	
	DOT-appr 6-8	January 18, 2012		8-6	January 18, 2012	
	DOT-appr 6-9	January 18, 2012		8-7	January 18, 2012	
	DOT-appr 6-10	January 18, 2012		8-8	January 18, 2012	
	DOT-appr 6-11	January 18, 2012		9	9-1	January 18, 2012
	DOT-appr 6-12	January 18, 2012			9-2	January 18, 2012
	DOT-appr 6-13	January 18, 2012				
	DOT-appr 6-14	January 18, 2012		Supp. 1	S1-1	January 18, 2012
	DOT-appr 6-15	January 18, 2012			S1-2	January 18, 2012
		S1-3	January 18, 2012			

RECORD OF REVISIONS

Revisions to this manual, with the exception of actual weighing data, are recorded in the following table.

Revisions of approved sections must be endorsed by the responsible airworthiness authority.

The new or amended text will be indicated by a bold black vertical line in the left hand margin of a revised page. Revision No. and reference will be shown on the bottom left hand corner of the page.

The airplane may only be operated if the Flight Manual is up to date.

Rev. No	Affected Pages	Approved	
		Date	Name
Issue 1	All	20 December, 2000	W. Jupp Chief, Flight Test For, Director, Aircraft Certification Transport Canada
Revision 1	0-4, 0-5, 0-6, 1-9, 2-6, 3-2, 3-13, 5-7, 5-10, 5-12, 5-13, 6-8, 6-9, 6-10.	09 Mar., 2001	W. Jupp Chief, Flight Test For, Director, Aircraft Certification Transport Canada
Revision 2	0-4, 0-5, 0-6, 0-9, 1-7, 2-5, 2-7, 2-15, 3-1, 5-12, 6-10, 7-12.	18 Nov., 2003	W. Jupp Chief, Flight Test For, Director, Aircraft Certification Transport Canada
Revision 3	0-4, 0-5, 0-6, 5-1, 5-7, 5-8, 5-9, 5-10, 5-11, 5-12, 5-13, 5-14, 5-15.	March 19, 2004	M. Brusette Chief, Flight Test For, Director, Aircraft Certification Transport Canada
Revision 4	0-4, 0-6, 1-8.	August 22, 2006	M. Brusette Chief, Flight Test For, Director, Aircraft Certification Transport Canada
Revision 5	0-4 to 0-10, 1-8, 2-15, 4-9, 4-10, 4-15, 4-16, 6-14, 6-15, 7-9, 7-12, 8-1, 8-8, 9-1, 9-2.	7 January 2013	 Chief, Flight Test for Director, National Aircraft Certification TRANSPORT CANADA

[INTENTIONALLY LEFT BLANK]

REVISION LOG

This log should be used for control of all revisions issued and installed in this manual. The affected pages of any revision as well as the Record of Revisions must be inserted into the manual upon receipt. The pages superseded by the revision must be removed and destroyed. The Revision Log should be updated by hand. Changes are identified on those pages affected by a revision bar.

Rev. No.	Date Issued:	Inserted On:	Inserted By:
Issue 1	20 Dec., 2000	20 Dec., 2000	Diamond Aircraft
Revision 1	09 Mar., 2001	09 Mar., 2001	Diamond Aircraft
Revision 2	18 Nov., 2003	18 Nov., 2003	Diamond Aircraft
Revision 3	19 Mar., 2004	19 Mar., 2004	Diamond Aircraft
Revision 4	22 Aug., 2006	22 Aug., 2006	Diamond Aircraft
Revision 5	18 Jan., 2012	10 Jan., 2013	Diamond Aircraft

REVISION HIGHLIGHTS

Changes of **technical material** in Revision 5 of the AFM are described below and are indicated in the text pages by revision bars in the margin adjacent to the change. The footer has been changed on all pages of the manual to be consistent and correct. This will not show in the Revision Highlights Page.

Chapter	Pages	Highlights
0	0-4 and 0-5 0-6 0-7 0-8 0-9 0-10	List of Effective Pages revised. Rev bars inserted adjacent to the changed pages. Record of Revised Pages and Approval for Revision 5. Blank Page. Revision Log entries. Revision Highlights page added for Revision 5. Changed due to pagination.
1	1-8	Added alternate replacement for the EVANS NPG+ waterless coolant with a 50/50 Glycol type coolant - DA20-72-03L, Rev 2.
2	2-4 2-15 2-16	Revised the CHT with SB DA20-72-03L Installed. Revised Placard added for aircraft without SB DA20-72-03L installed. Placard added above CHT gauge if SB DA20-72-03L is installed.
4	4-9 4-10 4-15 and 4-16	Caution added to Para 4.4.2 Before Starting engine. Spelling of Tanis corrected. Notes for Carburetor Icing revised. Paras renumbered.
6	6-14 6-15	Part number for the RPM Indicator changed. Equipment List table revised to show "Arm" Column.
7	7-9 7-12	Caution added to Para 7.8 CANOPY. Graphic revised and page re-formatted. Warning added related to turning the propeller.
8	8-1 8-8	Table of Contents numbering revised. Item 8.6 GROUND DE-ICING added. Para 8.6 GROUND DE-ICING added.
9	9-1 and 9-2	Header added to the Chapter. "DOT Approved" removed from the footer pages.

SUBSCRIPTION SERVICE

Diamond Aircraft Publications Revision Subscription Contacts

To ensure safe operation and maintenance of the DA20/100 Katana aircraft, it is recommended that operators verify that their documentation is at the correct issue/revision levels. For revision and subscription service please contact the following:

1. DA20/100 Katana related manuals and publications.

North America, Australia, South Africa:

Diamond Aircraft Industries Inc.
Customer Support
1560 Crumlin Sideroad
London, Ontario
Canada
N5V 1S2
www.diamondair.com
Phone: 519-457-4041
Fax: 519-457-4045

Europe, Other:

Diamond Aircraft Industries GmbH
Customer Support
N.A. Otto-Strasse 5
A-2700 Wiener Neustadt
Austria
www.diamond-air.at
Phone: 011-43-2622-26700
Fax: 011-43-2622-26780

2. Rotax 912 Engine related manuals and publications.

North America:

Rotec Research Canada LTD.
6235 Okanagan Landing Road
Vernon, British Columbia
Canada
V1H 1M5
www.rotec.com
Phone: 250-260-6299
Fax: 250-260-6269

HB- FLUGTECHNIK GES.M.B.H.
Dr. Adolf Scharf Str. 44
A-4053HAID

www.rotax.bombardier.com
Phone: 07229 / 79104/79117
Fax: 07229 / 79104 15

OR Contact your authorized Rotax Engine distributor as listed in the back of the 912 Operators Manual.

3. Hoffmann Propeller Model HO-V352 related manuals and publications.

North America, Australia, South Africa:

Diamond Aircraft Industries Inc.
Customer Support
1560 Crumlin Sideroad
London, Ontario
Canada
N5V 1S2
www.diamondair.com
Phone: 519-457-4041
Fax: 519-457-4045

Europe, Other:

Hoffmann Propeller GmbH. & Co.
Customer Support
Kupferlingstr. 9
D-83022 Rosenheim
Germany
Phone: 011-49-8031-1878-0
Fax: 011-49-8031-1878-78

CHAPTER 1

GENERAL

1.1. INTRODUCTION	1- 1
1.2. CERTIFICATION BASIS	1- 2
1.3. WARNINGS, CAUTIONS, AND NOTES	1- 2
1.4. THREE-VIEW-DRAWING OF AIRPLANE	1- 3
1.5. DIMENSIONS	1- 4
1.6. ENGINE	1- 5
1.7. PROPELLER	1- 5
1.8. FUEL	1- 6
1.9. LUBRICANT AND COOLANT	1- 7
1.10. WEIGHT	1- 9
1.11. LIST OF DEFINITIONS AND ABBREVIATIONS	1- 10
1.12. CONVERSION FACTORS	1- 14

1.1. INTRODUCTION

The Airplane Flight Manual has been prepared to provide pilots and instructors with information for the safe and efficient operation of this airplane.

This Manual includes the material required by JAR-VLA including amendment VLA/92/1. It also contains supplemental data supplied by the airplane manufacturer that can be useful to the pilot.

The Flight Manual conforms to a standard equipped DA 20/100 KATANA. Any optional equipment installed on request of the customer (COMM, NAV, etc.) is not considered.

For the operation of optional equipment the Operation Manual of the respective vendor must be used.

For permissible accessories refer to the equipment list, Section 6.5.

1.2. CERTIFICATION BASIS

The DA 20/100 has been approved by Transport Canada as meeting the requirements of JAR-VLA and amendment VLA/92/1. The Type Certificate No. A-191, originally issued on July 29th, 1994, has been revised to include the DA20/100.

Category of Airworthiness: NORMAL

Noise Certification Basis: a) Canadian Airworthiness Manual Chapter 516
b) FAA Part 36
c) LBA: LSL Chapter X of 1.01.1991

For others, refer to the national type certificate data sheets, as applicable.

1.3. WARNINGS, CAUTIONS, AND NOTES

The following definitions apply to warnings, cautions, and notes used in the Flight Manual:

WARNING

means that the non-observation of the corresponding procedure leads to an immediate or important degradation of the flight safety.

CAUTION

means that the non-observation of the corresponding procedure leads to a minor or to a more or less long term degradation of flight safety.

NOTE

draws the attention to any special item not directly related to safety but which is important or unusual.

1.4. THREE-VIEW-DRAWING OF AIRPLANE

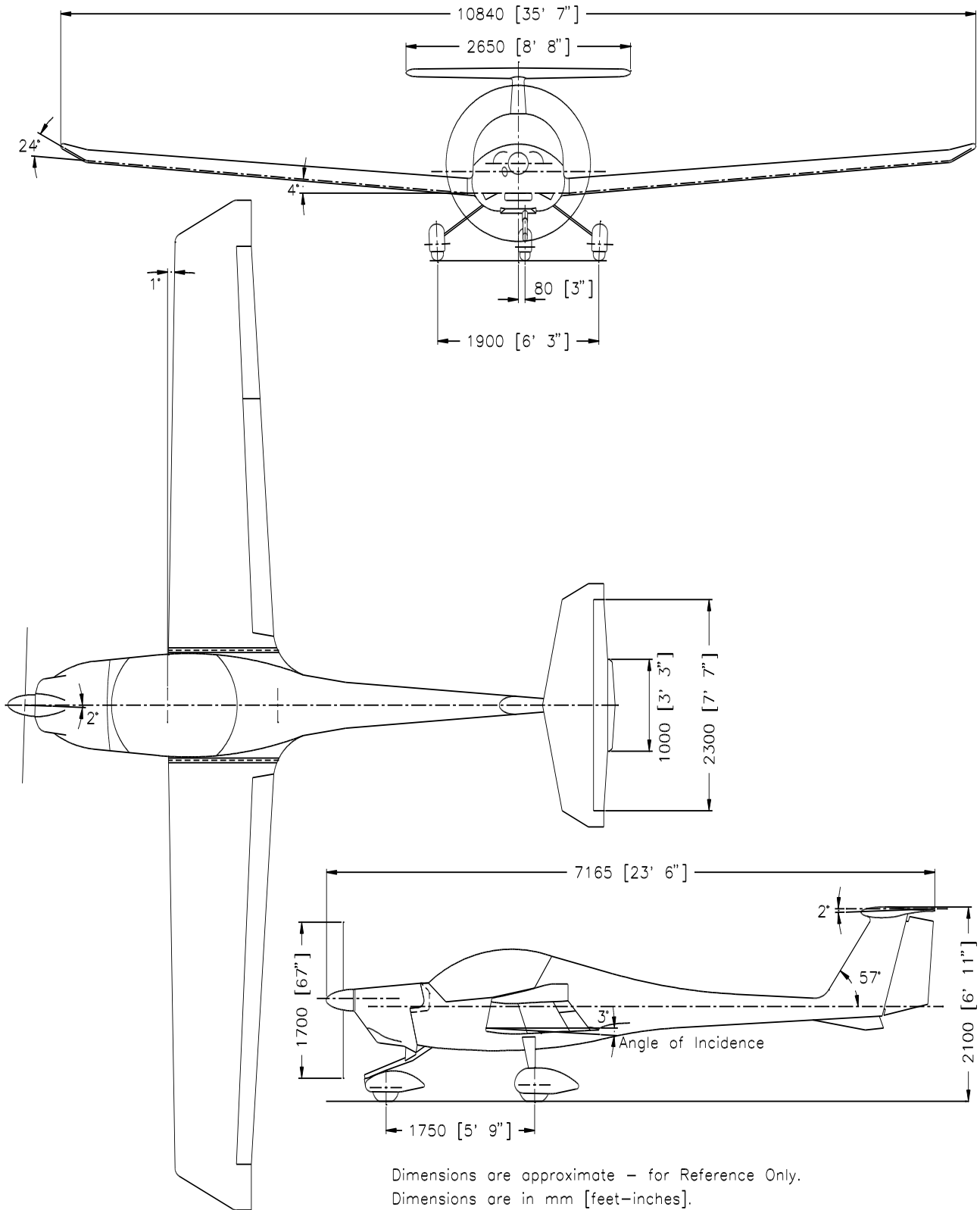

1.5. DIMENSIONS

1.5.1 Overall Dimensions

Span:	35 ft 7 in (10.84 m)
Length:	23 ft 6.0 in (7.17 m)
Height:	6 ft 11.0 in (2.10m)

1.5.2 Wing

Airfoil:	Wortmann FX 63-137/20 HOAC
Wing Area:	125 sq.ft. (11.6 m ²)
Mean Aerodynamic Chord (MAC):	3 ft 6.9 in (1.09 m)
Aspect Ratio:	10.0
Dihedral:	+4° nominal
Sweep of Leading Edge:	+1° nominal

1.5.3 Horizontal Stabilizer

Angle of Incidence :	-2.5° ±0.5°
Span:	8 ft 8 in (2.65 m)

1.5.4 Landing Gear

Track:	6 ft 3 in (1.90 m)
Wheel Base:	5 ft 9 in (1.75 m)
Tire Size:	Nose: 4.00-4 (TOST) 5.00-4 (GOODYEAR)
	Main:* 15 x 6.00-5 (GOODYEAR) or 5.00 x 5, 6 Ply (TSO C62)
Tire Pressure:	Nose: 26 psi (1.8 bar) Main: 33 psi (2.3 bar)

* Main tires must be same brand, model and size.

1.6. ENGINE

Rotax 912S, 4 Cylinder, 4 Stroke-Engine, horizontally opposed, liquid cooled cylinder heads, air-cooled cylinders.

Propeller drive via integrated reduction gear.

Reduction Ratio:	2.43 : 1
Displacement:	82.5 cu.in. (1.352 liters)
Output Power:	100 hp (73.5 kW)
at	2385 RPM

1.7. PROPELLER

Two-bladed variable pitch propeller, model HO-V352F/170FQ **OR**
manufactured by HOFFMANN, model HO-V352F/C170FQ
Constant speed, hydraulic pitch control

Range of Pitch Angle:	10° - 35°
Diameter:	5 ft 6.9 in (1.70 m)

1.8. FUEL

Approved Fuel Grades: AVGAS 100LL
Automotive Gasoline, Unleaded, Minimum
95 RON or 91 AKI
RON = Research Octane Number
MON = Motor Octane Number
AKI = Anti Knock Index = $\frac{MON + RON}{2}$
Specifications: Europe - EN 228
USA - ASTM D4814
Canada – CAN/CGSB-3.5-94
(or more current issue)

Total Fuel Capacity: 20.1 US gal. (76 liters)

Usable Fuel: 19.5 US gal. (74 liters)

Unusable Fuel: 0.6 US gal. (2 liters)

CAUTION

Use of automotive gasoline containing alcohol (e.g.: methanol or ethanol) other than specified in the above listed specifications, is not permitted.

NOTE

Petroleum suppliers provide automotive gasoline of varying volatilities, depending on the season and climatic zone. Fuels with higher volatility (“cold weather” grade fuels) are more susceptible to fuel vapour formation than fuels with lower volatility (“hot weather” grade fuels), at equal temperatures. Use of fuels dispensed in winter or in colder climatic zones, under high ambient temperature conditions, increases the risk of vapor formation and subsequent possible engine malfunction.

1.9. LUBRICANT AND COOLANT

1.9.1. Lubricant

Use only motor oil with API classification SF or SG or higher.

Due to high stresses in the reduction gears, a 4 stroke motorcycle oil of a registered brand with gear additives that meets API classification SF or SG are highly recommended.

The viscosity should be selected according to the various climatic conditions using the following table.

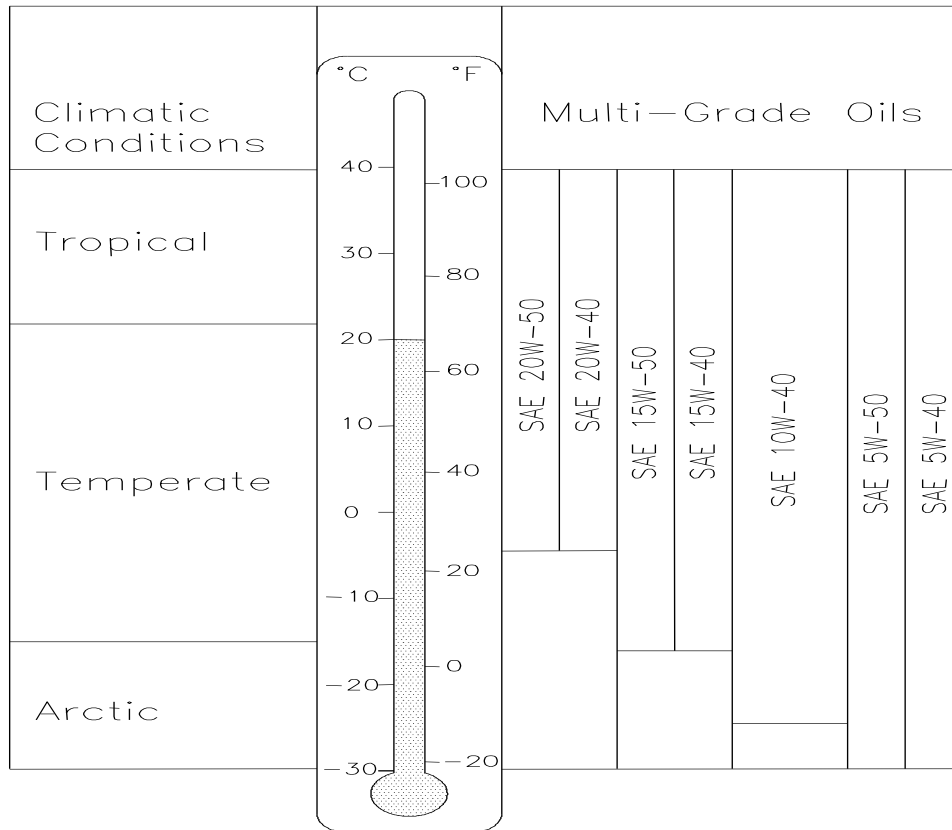

CAUTION

Do not use aviation lubricant!

When operating with AVGAS100LL fuel do not use synthetic oil.

Oil Capacity: Minimum : 3.0 liters (3.2 US qt.)
 Maximum : 3.4 liters (3.6 US qt.)

1.9.2. Coolant

EVANS NPG+ waterless coolant or an alternate coolant as provided by Service Bulletin

DA20-72-03L, Rev 2 must be used.

WARNING

In the case of using EVANS NPG+, water or water-containing coolant must **not** be added **in any case** to the cooling system.

CAUTION

The coolant manufacturer's data for change/replacement, usage, and operation are to be observed.

Installed Service Bulletin DA20-72-03L, Rev 2 - dated July 23, 2009 provides an alternate replacement for the EVANS NPG+ waterless coolant with a 50/50 Glycol type coolant as stipulated in EASA AD No. 2007-0155.

(a) Coolant Capacity:

Minimum : 2.5 US qt. (2.4 liters)

Maximum : 2.6 US qt. (2.5 liters)

(b) Reservoir Capacity:

Minimum : 0.11 US qt. (0.1 liters)

Maximum : 0.21 US qt. (0.2 liters)

NOTE

The level in the reservoir can be checked using the coolant dipstick. Excessive overfilling of the reservoir can result in overflow during operation. In the event of a completely empty reservoir, the coolant level in the dispatcher vessel on top of the engine must also be checked.

1.10. WEIGHT

Maximum Take-off Weight	: 750 kg (1653 lbs)
Maximum Landing Weight	: 750 kg (1653 lbs)
Empty Weight	: See Chapter 6
Maximum Weight in Baggage Compartment	: 20 kg (44 lbs) only if restraining devices available

Wing Loading

At Maximum Take-off Weight	: 64.61 kg/m ² (13.23 lbs/sq.ft.)
Performance Load at Max. Take-off Weight	: 7.50 kg/hp (16.53 lbs/hp.)

1.11. LIST OF DEFINITIONS AND ABBREVIATIONS

1.11.1. Speed

AGL: Above Ground Level

CAS: Calibrated airspeed; Indicated speed corrected for installation and instrument errors. CAS is equal to TAS at standard atmospheric conditions at MSL.

KCAS: CAS in knots.

IAS: Indicated airspeed as shown on the airspeed indicator.

KIAS: IAS indicated in knots.

GS: Ground Speed. Speed of the airplane relative to the ground.

TAS: True airspeed. Speed of the airplane relative to air. TAS is CAS corrected for altitude and temperature errors.

v_A : Maneuvering speed. Maximum speed at which the airplane is not overstressed at full deflection of control surfaces.

v_{FE} : Maximum speed with flaps extended.

v_{NE} : Speed which must never be exceeded in any operation.

v_{NO} : Maximum structural cruising speed which should only be exceeded in calm air, and then only with caution.

v_S : The power-off stall speed with the airplane in its standard configuration.

v_{SO} : The power-off stall speed with the airplane in landing configuration.

v_X : Best angle-of-climb speed.

v_Y : Best rate-of-climb speed.

1.11.2. Meteorological Terms

ISA: International Standard Atmosphere at which air is identified as a dry gas. The temperature at mean sea level is 15° Celsius (59° F), the air pressure at sea level is 1013.25 mbar (29.92 inHg), the temperature gradient up to the altitude at which the temperature reaches -56.5° C (-67.9° F) is -0.0065° C/m (-0.0036° F/ft) and 0° C/m (0° F/ft) above.

OAT: Outside air temperature.

AGL: Above Ground Level

Indicated Pressure Altitude:

Altitude reading with altimeter set to 1013.25 mbar (29.92 inHg) air pressure.

Pressure Altitude:

Altitude measured at standard pressure at MSL (1013.25 mbar / 29.92 inHg) using a barometric altimeter. Pressure altitude is the indicated altitude corrected for installation and instrument errors. Within this manual the instrument errors are assumed to be zero.

Aerodrome/Airport Pressure:

Actual atmospheric pressure at the aerodrome/airport altitude.

Wind: The wind speeds used in the diagrams in this manual should be referred to as headwind or tailwind components of the measured wind.

1.11.3. Powerplant

Take-off Power:

Maximum engine power for take-off.

Maximum Continuous Power:

Maximum permissible continuous engine output power during flight.

1.11.4. Flight Performance and Flight Planning

Demonstrated Crosswind Component:

The maximum speed of the crosswind component at which the maneuverability of the airplane during take-off and landing has been demonstrated during type certification test flights.

Service Ceiling:

The altitude at which the maximum rate of climb is 0.5 m/s (100 ft/min.).

1.11.5. Weight and Balance

Reference Datum (RD):

An imaginary vertical plane from which all horizontal distances for the center of gravity calculations are measured. It is the plane through the leading edge of the wing root rib, perpendicular to the longitudinal axis of the airplane.

Station:

A defined point along the longitudinal axis which is generally presented as a specific distance from the reference datum.

Lever Arm:

The horizontal distance from the reference datum to the center of gravity (of a component).

Moment:

The weight of a component multiplied by its lever arm.

Center of Gravity (CG):

Point of equilibrium for the airplane weight.

CG position:

Distance from the reference datum to the CG. It is determined by dividing the total moment (sum of the individual moments) by the total weight.

Center of Gravity Limits:

The CG range which an airplane with a given weight must be operated within.

Usable Fuel:

The amount of fuel available for the flight plan calculation.

Unusable Fuel:

The amount of fuel remaining in the tank, which cannot be safely used in flight.

Empty Weight:

Weight of the airplane including unusable fuel, all operating fluids and maximum oil amount.

Useful Load:

The difference between take-off weight and empty weight.

Maximum Take-off Weight:

Maximum weight permissible for take-off.

1.11.6. Equipment

ACL: Anti collision light

1.11.7 Miscellaneous

GFRP - Glass Fibre Reinforced Plastic

CFRP - Carbon Fibre Reinforced Plastic

1.12. CONVERSION FACTORS

1.12.1. Length or Altitude

$$1 \text{ [ft.]} = 0.3048 \text{ [m]}$$

$$1 \text{ [in.]} = 25.4 \text{ [mm]}$$

1.12.2. Speed

$$1 \text{ [kts]} = 1.852 \text{ [km/h]}$$

$$1 \text{ [mph]} = 1.609 \text{ [km/h]}$$

1.12.3. Pressure

$$1 \text{ [hPa]} = 100 \text{ [N/m}^2\text{]} = 1 \text{ [mbar]}$$

$$1 \text{ [in. Hg]} = 33.865 \text{ [hPa]}$$

$$1 \text{ [psi]} = 68.97 \text{ [mbar]}$$

1.12.4 Weight

$$1 \text{ [lbs]} = 0.454 \text{ [kg]}$$

1.12.5 Volume

$$1 \text{ [US gallon]} = 3.785 \text{ [liters]}$$

$$1 \text{ [Imperial gallon]} = 4.546 \text{ [liters]}$$

CHAPTER 2

OPERATING LIMITATIONS

2.1	INTRODUCTION	2-1
2.2	AIRSPEED LIMITATIONS	2-2
2.3	AIRSPEED INDICATOR MARKINGS	2-2
2.4	POWERPLANT LIMITATIONS	2-3
2.5	POWERPLANT INSTRUMENT MARKINGS	2-5
2.6	MISCELLANEOUS INSTRUMENT MARKINGS	2-5
2.7	WEIGHT	2-6
2.8	CENTER OF GRAVITY	2-6
2.9	APPROVED MANEUVERS	2-7
2.10	MANEUVERING LOAD FACTORS	2-7
2.11	MAXIMUM PASSENGER SEATING	2-8
2.12	FLIGHT CREW	2-8
2.13	KINDS OF OPERATION	2-8
2.14	FUEL	2-9
2.15	PLACARDS	2-9
2.16	DEMONSTRATED CROSSWIND COMPONENT	2-17
2.17	TEMPERATURE LIMITS	2-17

2.1. INTRODUCTION

Chapter 2 of this Flight Manual comprises the operating limitations, instrument markings, airspeed indicator markings, and the limitation placards which are necessary for the safe operation of the airplane, its engine, and standard systems and equipment.

The operating limitations in this Chapter and Chapter 9 have been approved by the Department of Transport (DOT), and must be complied with for all operations.

WARNING

These limitations must be complied with for all operations.

2.2. AIRSPEED LIMITATIONS

Speed	IAS			Remarks
	kts	mph	km/h	
V _A Maneuvering Speed	104	120	193	Do not make full or abrupt control movement above this speed, because under certain conditions the airplane may be overstressed by full control movement.
V _{FE} Maximum Flap Extended Speed	81	93	150	Do not exceed this speed with flaps extended
V _{NO} Maximum Structural Cruising Speed	118	135	218	Do not exceed this speed except in smooth air, and then only with caution
V _{NE} Never Exceed Speed	161	185	298	Do not exceed this speed in any operation

2.3. AIRSPEED INDICATOR MARKINGS

Marking	IAS			Explanation
	kts	mph	km/h	
White Arc	37-81	43-93	69-150	Operating range with extended flaps
Green Arc	41-118	47-135	76-218	Normal operating range
Yellow Arc	118-161	135-185	218-298	Maneuvers must be conducted with caution and only in smooth air.
Red Line	161	185	298	Maximum permissible speed for all operating modes

2.4. POWER PLANT LIMITATIONS

2.4.1. Engine

- (a) **Engine Manufacturer** : Bombardier Rotax, Gunskirchen/Austria
 (b) **Engine Type Designation** : 912 S3

NOTE

The propeller is driven by the engine via a reduction gear with a ratio of 2.43:1. The RPM indicator indicates the propeller speed. For that reason, all speed references within this manual - contrary to the engine manual - are propeller speeds.

(c) Engine Operating Limitations

- Max. T/O Power (5 min.) : 100 hp / 73.5 kW
 Max. Permissible T/O RPM : 2385 RPM
- Max. Continuous Power : 93 hp / 69 kW
 Max. Permissible Continuous RPM : 2260 RPM

(d) Oil Pressure

- Minimum : 12 psi (.8 bar) Below 1440 RPM
 Normal : 29 psi – 73 psi (2.0-5.0 bar) Above 1440 RPM
 Max. in case of Cold-start (short-term) : 102 psi (7.0 bar)

(e) Fuel Pressure

- Minimum : 2.2 psi (0.15 bar)
 Maximum : 5.8 psi (0.40 bar)

(f) Oil Temperature

- Minimum : 122°F (50°C)
 Maximum : 266°F (130°C)

(g) Cylinder Head Temperature

Maximum : 275°F (135°C)

**With Service Bulletin DA20-72-03L
Rev 2 installed:**

Maximum : 253 °F (122.8 °C)

(h) Fuel Specifications

Approved Fuel Grades : AVGAS 100LL
Unleaded Automotive Fuel 95 RON /91 AKI
(refer also to page 1-6)

(i) Oil Grades

: 4 stroke motorcycle oil of a registered brand with gear additives that meets or exceeds API classification SF or SG are highly recommended.

(also see Page 1-7 for additional information on the selection of suitable lubricants)

2.4.2. Propeller

(a) Propeller Manufacturer : Hoffmann Propeller, Rosenheim/Germany

(b) Propeller Type : HO-V352F/170FQ OR
HO-V352F/C170FQ

(c) Propeller Diameter : 5 ft 6.9 in (1.70 m)

(d) Propeller Pitch (at 3/4 radius) : 10° - 35°

(e) Propeller Speed Limitations

Max. T/O RPM (max. 5 min.) : 2385 RPM

Max. Continuous RPM : 2260 RPM

2.5. POWERPLANT INSTRUMENT MARKINGS

Powerplant instrument markings and their color code significance are shown below:

Instrument	Red Line = Lower Limit	Green Arc = Normal Operating Range	Yellow Arc = Caution Range	Red Line = Upper Limit
Tachometer	-	*600 - 2260 RPM	2260 - 2385 RPM	2385 RPM
Oil Temperature Indicator	122° F 50° C	122- 266° F 50 - 130° C	-	266° F 130° C
Cylinder Head Temperature Indicator	-	-	-	275° F 135° C
Oil Pressure Indicator	12 psi 0.8 bar	29 - 73 psi 2 - 5 bar ABOVE 1440 RPM	12 – 29 psi 0.8 – 2 bar BELOW 1440 RPM <hr/> 73 - 102 psi 5 - 7 bar	102 psi 7 bar

* Recommended nominal idle speed = 950 RPM

2.6. MISCELLANEOUS INSTRUMENT MARKINGS

Instrument	Red Line = Lower Limit	Green Arc = Normal Operating Range	Yellow Arc = Caution Range	Red Line = Upper Limit
Voltmeter	8-11 Volts	12.5 - 16 Volts	11 - 12.5 Volts	16.1 Volts

2.7. WEIGHT

Maximum permissible weight	: 750 kg (1653 lbs)
Maximum permissible weight in the baggage compartment	: 20 kg (44 lbs) only permissible with baggage harness

WARNING

Exceeding the weight limitations may lead to overloading of the airplane, as well as degrading of the handling characteristics and flight performance.

2.8. CENTER OF GRAVITY

The reference datum (RD) for the center of gravity (CG) calculation is tangent to the leading edge of the wing at the root rib. This plane is vertical when the fuselage is horizontal. Procedures for horizontal alignment, as well as particulars with regard to the empty weight center of gravity, refer to Chapter 6.

Most forward CG (all weights)	: 250 mm (9.84 in) aft of RD
Most rearward CG (all weights)	: 390 mm (15.35 in) aft of RD

WARNING

Exceeding the center of gravity limitations reduces the maneuverability and stability of the airplane.

The procedure used to determine the center of gravity is described in Chapter 6.

2.9. APPROVED MANEUVRRES

This airplane is certified in the NORMAL Category in accordance with JAR-VLA.

Permissible Normal Category Maneuvres:

- a) All normal flight maneuvers
- b) Stalls (except WHIP stalls)
- c) Lazy Eight's Entry speed: 116 kts (215 km/h)
 Chandelles: Entry speed: 116 kts (215 km/h)
 Steep turns in which the angle of bank does not exceed 60°

NOTE

Aerobatics are prohibited.

2.10. MANEUVERING LOAD FACTORS

Table of structural maximum permissible load factors:

	at v_A :	at v_{NE} :	with fully extended flaps
Positive	+ 4.4	+ 4.4	+ 2.0
Negative	- 2.2	- 2.2	0

WARNING

Exceeding the maximum load factors will result in overstressing of the airplane. Simultaneous full deflection of more than one control surface can result in overstressing of the structure, even at speeds below the maneuvering speed.

2.11. MAXIMUM PASSENGER SEATING

Maximum Passenger Seating: one passenger.

2.12. FLIGHT CREW

Minimum Flight Crew: one pilot,
aircraft to be flown solo from left seat only

2.13. KINDS OF OPERATION

Flights are permissible in accordance with day visual flight rules.

Minimum Equipment, Flight and Navigation Instruments:

- Airspeed Indicator
- Altimeter
- Magnetic Compass

Minimum Equipment, Powerplant Instruments:

- Fuel Quantity Indicator
- Oil Pressure Indicator
- Oil Temperature Indicator
- Manifold Pressure Indicator
- Cylinder Head Temperature Indicator
- Tachometer
- Fuel Pressure Warning Light
- Voltmeter
- Ammeter
- Generator Warning Light

Note: Additional equipment may be required for compliance with specific operational or specific national requirements. It is the operators responsibility to ensure compliance with any such specific equipment requirements.

2.14. FUEL

Fuel Capacity

Total Fuel Quantity:	: 20.1 US gal. (76 liters)
Usable Fuel:	: 19.5 US gal. (74 liters)
Unusable Fuel:	: 0.53 US gal. (2 liters)

2.15. PLACARDS

The following placards must be installed:

1. On the instrument panel next to airspeed indicator

Effective for all aircraft operated strictly under JAR-VLA regulations

This airplane is classified as a very light airplane approved for day VFR only, in non-icing conditions. All aerobatic manoeuvres, including intentional spinning, are prohibited. See Flight Manual for other limitations.

2. On the instrument panel under the airspeed

Maneuvering speed $V = 104\text{kts}$

3. Next to the switches

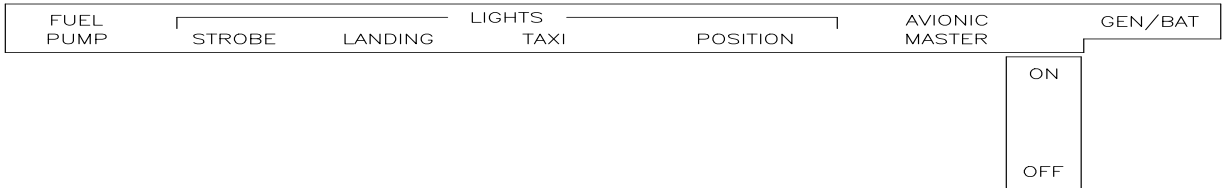

4. On the flap control

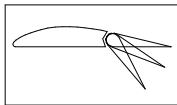

Flaps

5. On the dimming switch for trim display, flap control and GPS (if installed)

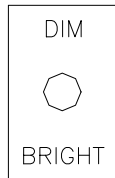

6. Next to dimming potentiometer for cabin and fuel shut-off valve light

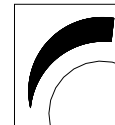

7. On the instrument panel next to the individual circuit breakers

CHT/OIL PRESS.					
OIL TEMP FUEL QTY OAT	COM/NAV 1				
FUEL PUMP	COM/NAV 2	COM/NAV 1			
LANDING LIGHT	ATC	ATC			
TAXI LIGHT	ICS	ICS			
INTERNAL LIGHTS	AVIONIC MASTER	AVIONIC MASTER			
POSITION LIGHTS	AVIONIC MASTER CONTR.	AVIONIC MASTER CONTR.			
ACL	HORIZON	HORIZON			
START	D.G.	D.G.	ADF	COM/GPS 2	COM/NAV 2
GEN. CONTROL	TURN & BANK	TURN & BANK	DME	DME	DME
GEN.	FLAPS	FLAPS	MARKER	OR* MARKER	OR* MARKER
BATTERY	TRIM	TRIM	GPS	ADF	ADF

* Depending on aircraft specific avionic equipment configuration.

8. On top of the instrument panel under the compass

FOR	N	30	60	E	120	150
STEER						
FOR	S	210	240	W	300	330
STEER						
DATE	<i>Airpath</i>					

9. Around Trim Display on top of the instrument panel

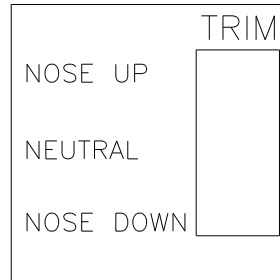

10. On top the instrument panel within pilot's direct line of vision

No smoking!

11. On DME channeling switch on the RH side of the radio stack (optional)

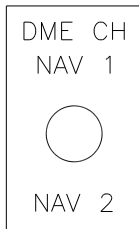

12. Above RH air vent on the instrument panel (optional)

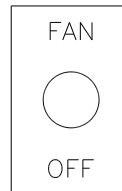

13. Above the OAT indicator

O.A.T.

14. Below Microphone jack on LH side of the instrument panel

Mic

15. On the fuel quantity gauge

Usable
74L/19.5 US gal.

16. Next to GPS (if installed)

GPS limited for VFR only

17. Under the instrument panel next to the individual knobs

CABIN HEAT
Pull-ON

CHOKE
Pull-ON

CARB HEAT
Pull-ON

PARKING BRAKE
Pull

18. On the centre console between throttle and propeller levers

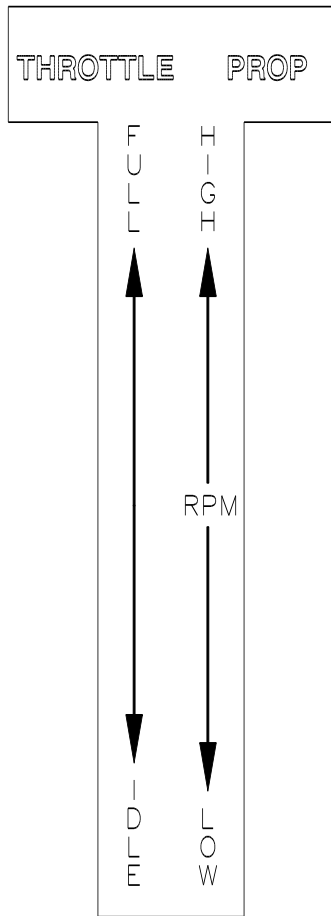

19. On the side of the throttle quadrant next to tension adjustment knob

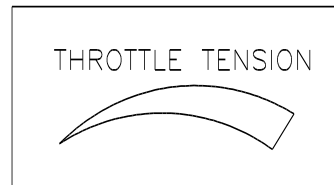

20. Next to trim switch on the centre console

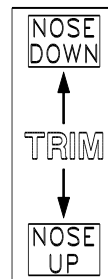

21. Next to instrument and map light switches on the centre console

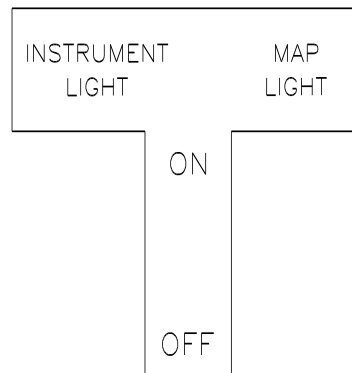

22. Next to fuel shut-off valve in correct position

Fuel Valve
CLOSED

Fuel Valve
OPEN

23. Next to canopy release handles

Inside Left (partially coloured red)

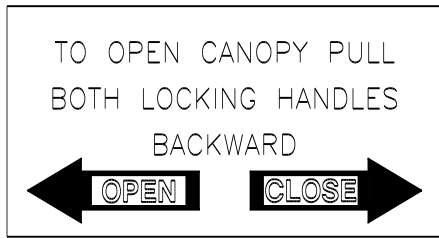

Inside Right (partially coloured red)

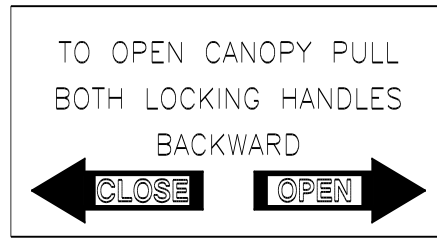

Outside Left

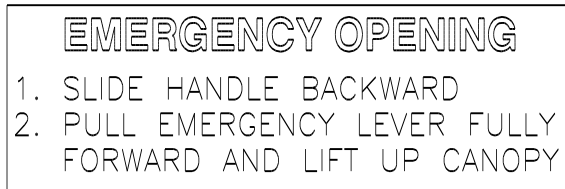

Outside Right



24. Next to ELT (if installed) to indicate switch position for EBC 102A ELT model

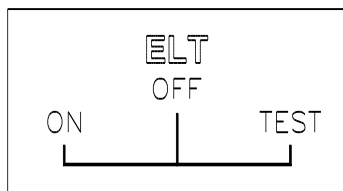

for EBC 502 ELT model

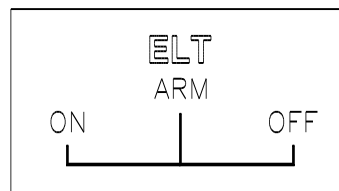

25. Next to Headset Jacks on the Back Rest Pilot side (LH)

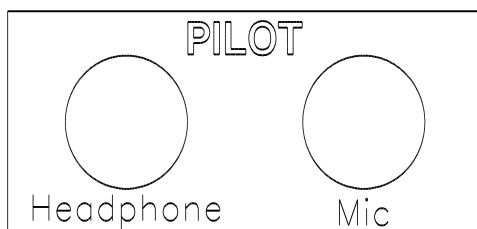

Co-pilot side (RH)

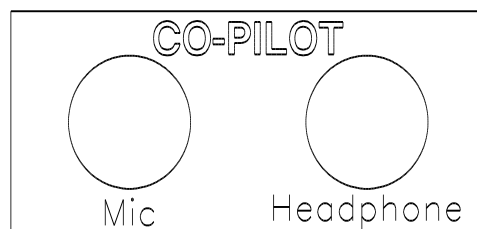

26. On the LH side of baggage compartment

MAX. BAGGAGE - 44 lbs (20kg)
ONLY WITH BAGGAGE NET

27. On the brake fluid reservoirs (rudder pedals)

Hydraulic Fluid
MIL-H-5606

28. On inside of oil filler door (coloured red)

CAUTION
DO NOT USE AVIATION
GRADE OIL !

29. On oil filler cap

OIL 3.4 l

SAE 15W-40
OR ACCORDING TO
FLIGHT MANUAL

30. On coolant equalizing reservoir

COOLANT

Placard on reservoir cap.
Placard is not applicable to aircraft with Service Bulletin DA20-72-03L, Rev 2 installed.

31. On coolant dispatcher vessel

COOLANT



32. Next to fuel filler cap

TOTAL QTY: 76 Liters/20.1 US Gals.
USABLE QTY: 74 Liters/19.5 US Gals.
• AVGAS 100LL
• AUTOMOTIVE GASOLINE UNLEADED, MIN 95 RON/91 AKI
(Any mixtures of the above are permissible Refer to Flight Manual for Specifications)

33. On fuselage upper skin behind cockpit (only if ELT is installed), coloured yellow



34. On fuselage underside (belly), by left wing



35. Under each wing and tail skid plate



36. Around Stall Warning Hole in left wing



37. On Nose Landing Gear Strut

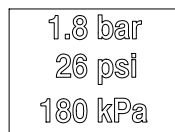

38. On Main Landing Gear Strut

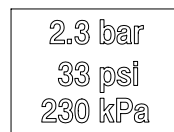

39. Above the CHT gauge if Service Bulletin DA20-72-03L Rev 2 is installed:

MAX CHT = 253 °F (122.8 °C)

2.16. DEMONSTRATED CROSSWIND COMPONENT

The maximum demonstrated crosswind component is 15 kts. (27 km/h).

2.17. TEMPERATURE LIMITS

Limits for outside air temperature and temperature of the structure for the operation of the airplane:

Maximum T/O Temperature :

131°F (55°C)

Structural Temperature limit

For Indicator see pg.4-3

CHAPTER 3

EMERGENCY PROCEDURES

3.1.	INTRODUCTION	3- 2
3.2.	AIRSPEDS DURING EMERGENCY PROCEDURES	3- 2
3.3.	EMERGENCY PROCEDURES - CHECKLISTS	
3.3.1.	Engine Failures	
	(a) Engine Failure during Take-off Run	3- 3
	(b) Engine Failure after Take-off	
	I. Insufficient Engine Power	3- 3
	II. Engine Inoperative	3- 4
	(c) Engine Failure during Flight	
	I. Engine Running Roughly	3- 4
	II. Loss of Oil Pressure	3- 4
	III. Loss of Fuel Pressure	3- 4
	IV. Restarting the Engine with Propeller Windmilling	3- 5
	V. Restarting the Engine with Propeller at Full Stop	3- 6
3.3.2.	Emergency Landing	
	(a) Emergency Landing with Engine Off	3- 7
	(b) Precautionary Landing with Engine Power Available	3- 7
3.3.3.	Fire	
	(a) Engine Fire during Start on the Ground	3- 9
	(b) Engine Fire during Flight	3- 9
	(c) Electrical Fire including Smoke during Flight	3- 9
	(d) Electrical Fire including Smoke on the Ground	3-10
	(e) Cabin Fire during Flight	3-10
3.3.4.	Icing	
	Unintentional Flight into Icing Area	3-11
3.3.5.	Recovery from Unintentional Spin	3-11
3.3.6.	Landing with Defective Tire on Main Landing Gear	3-12
3.3.7.	[Intentionally left blank]	3-12
3.3.8.	Gliding	3-13
3.3.9.	Electrical Power Failure	3-13
3.3.10.	Flap System Failure	3-15
3.3.11.	Starter Failure	3-15
3.3.12.	Avionics System Failure	3-16
3.3.13.	Trim System Failure	3-17
3.3.14.	Instrument Panel Lighting Failure	3-18
3.3.15.	Tachometer failure	3-18

3.1. INTRODUCTION

The following chapter contains check-lists as well as descriptions of the recommended procedures in case of an emergency. Since it is impossible to present in the Flight Manual all emergency situations which may occur, knowledge of the airplane and experience of the pilot are essential in rectifying such problems.

3.2. AIRSPEEDS DURING EMERGENCY PROCEDURES

	V _{IAS}		
	kts	mph	km/h
Engine failure after take-off with flaps in T/O position	60	68	110
Manoeuvring Speed	104	120	193
Airspeed for best glide angle			
Wing Flaps in T/O Position 1653 lbs (750 kg)	73	84	135
Wing Flaps in T/O-Position 1322 lbs (600 kg)	66	76	121
Precautionary Landing (with power and Wing Flaps in landing position)	57	66	106
Emergency landing with engine off (Wing Flaps in T/O or LDG position)	57	66	106
Emergency landing with engine off (Wing Flaps UP)	65	75	120

3.3. EMERGENCY PROCEDURES - CHECKLISTS

3.3.1. Engine Failures

(a) Engine Failure during Take-off Run

1. Throttle IDLE
2. Brakes as required

(b) Engine Failure after Take-Off

I. INSUFFICIENT ENGINE POWER

1. Airspeed (V_{IAS}) 60 kts / 68 mph / 110 km/h
2. Throttle FULL
3. Carburetor Heat ON
4. Choke OFF
5. Fuel Shut-off Valve OPEN
6. Ignition Switch BOTH
7. Electric Fuel Pump ON
8. Propeller Speed Control Lever max. RPM

WARNING

If adequate engine performance cannot be restored immediately, prepare for an emergency landing. If possible, land straight ahead, avoiding obstacles.

Shortly before landing:

9. Fuel Shut-off Valve CLOSED
10. Ignition Switch OFF
11. Master Switch (Battery) OFF

II. ENGINE INOPERATIVE

Perform emergency landing according to paragraph 3.3.2.

(c) Engine Failure during Flight

I. ENGINE RUNNING ROUGHLY

- | | | |
|----|---------------------|--|
| 1. | Carburetor Heat | ON |
| 2. | Electric Fuel Pump | ON |
| 3. | Choke | check OFF |
| 4. | Fuel Shut-off Valve | check OPEN |
| 5. | Ignition Switch | cycle L - BOTH - R - BOTH |
| 6. | Throttle | at present position |
| 7. | No Improvement | reduce throttle to minimum
required power, land as soon
as possible. |

II. LOSS OF OIL PRESSURE

- | | | |
|----|--|---|
| 1. | Oil Temperature | check |
| 2. | If Oil Pressure drops below Green Arc
but Oil Temperature is normal | land at nearest airfield |
| | If Oil Pressure drops below Green Arc
and Oil Temperature is rising | reduce throttle to minimum required
power;
land as soon as possible. Be prepared
for engine failure and emergency
landing |

III. LOSS OF FUEL PRESSURE

- | | | |
|----|---|---|
| 1. | Electric Fuel Pump | ON, and land at nearest suitable airport |
| 2. | If Fuel Pressure Warning Light
does not extinguish | Land at nearest suitable airport. Be
prepared for engine failure and
emergency landing. |

IV. RESTARTING THE ENGINE WITH PROPELLER WINDMILLING

As long as the airspeed (v_{IAS}) is at least 54 kts / 62 mph / 100 km/h, the propeller will continue to windmill.

- | | | |
|----|-------------------------------|----------------------------|
| 1. | Airspeed (v_{IAS}) | 70 kts / 81 mph / 130 km/h |
| 2. | Wing Flaps | T/O Position |
| 3. | Propeller Speed Control Lever | max. RPM |
| 4. | Fuel Shut-off Valve | OPEN |
| 5. | Ignition Switch | BOTH |
| 6. | Electric Fuel Pump | ON |
| 7. | Throttle | 3/4 in (2 cm) forward |

If the engine does not start within 10 seconds: Cold Start

- | | | |
|-----|-----------------|-------------|
| 8. | Throttle | IDLE |
| 9. | Choke | ON (Pulled) |
| 10. | Ignition Switch | START |

V. RESTARTING THE ENGINE WITH PROPELLER AT FULL STOP

- | | | |
|----|--------------------------------|---|
| 1. | Electrically Powered Equipment | OFF |
| 2. | Master Switch (Battery) | ON |
| 3. | Propeller Speed Control Lever | max. RPM |
| 4. | Fuel shut off valve | OPEN |
| 5. | Electric Fuel Pump | ON |
| 6. | Throttle | Cold Start: IDLE
Warm Start: 3/4 in (2 cm) forward |
| 7. | Choke | Cold Start: ON (pulled)
Warm Start: OFF |
| 8. | Ignition Switch | START |

NOTE

The engine may also be re-started by increasing the airspeed by pushing the airplane into a descent and accelerating to approx. (V_{IAS}) 120 kts / 138 mph / 222 km/h. A loss of 1000 ft / 300 m altitude must be taken into account.

After successful re-start:

- | | | |
|-----|--------------------------------|----------------|
| 9. | Oil Pressure | check |
| 10. | Choke | OFF |
| 11. | Electrically Powered Equipment | ON if required |
| 12. | Oil Temperature | check |

3.3.2. Emergency Landing

(a) Emergency Landing Approach with Engine off

- | | | |
|----|--|--|
| 1. | Airspeed (V_{IAS}) (Flaps in T/O and LDG position) | 57 kts / 66 mph / 106 km/h |
| | Airspeed (V_{IAS}) (Flaps UP) | 65 kts / 75 mph / 120 km/h |
| 2. | Fuel Shut-off Valve | CLOSED |
| 3. | Ignition Switch | OFF |
| 4. | Safety Belts | secured |
| 5. | Radio | Transmit, giving location and intentions |
| 6. | Master Switch (Battery) | OFF |

(b) Precautionary Landing with Engine Power Available

NOTE

A precautionary landing would be required if continuing the flight would endanger the aircraft or its occupants. Such circumstances could include mechanical defects, low fuel quantity or deteriorating weather conditions.

- | | | |
|----|---|-------------|
| 1. | Search for a suitable place to land. Special attention must be given to wind direction and obstacles in the approach path | |
| 2. | Safety Belts | secured |
| 3. | Initiate Descent | |
| 4. | Throttle | as required |
| 5. | Trim | as required |
| 6. | Wing Flaps | as required |
| | (observe permissible speed) | |

- | | | |
|-----|---|--|
| 7. | Overfly selected landing area (not below 500 ft / 150 m above ground) to confirm suitability and that approach route is free of obstacles | |
| 8. | Climb up to 1000 ft AGL (if possible) | |
| 9. | Low pass over flight (around 100 feet) to observe any possible obstacles, such as cables, fences, ditches | |
| 10. | Climb up to 1000 ft AGL (if possible) | |
| 11. | Radio | Transmit, giving location and intentions |
| 12. | Final Approach | |
| | Throttle | as required |
| | Propeller Speed Control Lever | max. RPM |
| | Carburetor Heat | ON |
| | Electric Fuel Pump | ON |
| | Wing Flaps | LDG |
| | Airspeed (V_{IAS}) | 57 kts / 66 mph / 106 km/h |
| 13. | Touch-down is to be made with minimum airspeed, nose wheel should be kept above ground as long as possible | |
| 14. | After Touch-down: | |
| | Brake | as required |
| | Fuel Shut-off Valve | CLOSED |
| | Ignition Switch | OFF |
| | Master Switch (Battery) | OFF |

NOTE

If no suitable level landing area can be found, an up-hill landing should be performed, if possible.

3.3.3. Fire

(a) Engine Fire during Engine-Start-Up on the Ground

1. Fuel Shut-off Valve CLOSED
2. Throttle FULL
3. Master Switch (Battery) OFF
4. Ignition Switch OFF
5. Evacuate Airplane immediately

(b) Engine Fire during Flight

1. Fuel Shut-off Valve CLOSED
2. Airspeed (V_{IAS}) 70 kts / 81 mph / 130 km/h
3. Flaps T/O
4. Throttle FULL
5. Electric Fuel Pump OFF
6. Cabin Heat CLOSED
7. Perform emergency landing with engine off according to paragraph 3.3.2

(c) Electrical Fire including Smoke during Flight

1. Master Switch (Battery) OFF
2. Cabin Air OPEN
3. Fire Extinguisher use only if smoke development continues.

CAUTION

If fire extinguisher is used, the cabin must be aerated.

In case the fire is extinguished and electric power is required for continuation of the flight:

4. Avionics Master Switch OFF
5. Electrically Powered Equipment OFF
6. Master Switch (Battery) ON
7. Avionics Master Switch ON
8. Radio ON
9. Land as soon as possible.

(d) Electrical Fire including Smoke on the Ground

1. Master Switch (Battery) OFF

If engine running:

2. Throttle IDLE
3. Fuel Shut-off Valve CLOSED
4. Ignition Switch OFF
5. Canopy open
6. Fire Extinguisher deploy as required

(e) Cabin Fire during Flight

1. Master Switch (Battery) OFF
2. Cabin Air OPEN
3. Cabin Heat CLOSED
4. Fire Extinguisher deploy as required
5. Land as soon as possible

CAUTION

If fire extinguisher is used, the cabin must be aerated.

3.3.4. Icing

Unintentional Flight into Icing Area

1. Leave icing area (through change of altitude or change of flight direction to reach area with higher outside air temp.).
2. Continue to move control surfaces to maintain their moveability.
3. Carburetor Heat ON
4. Increase RPM to avoid icing of propeller blades (observe maximum RPM)
5. Cabin Heat OPEN

CAUTION

In case of icing on the leading edge of the wing, the stall speed will increase.

CAUTION

In case of icing on wing leading edge, erroneous indicating of the airspeed, altimeter, rate of climb and stall warning should be expected.

3.3.5. Recovery from Unintentional Spin

1. Throttle IDLE
2. Rudder fully applied opposite to direction of spin
3. Control Stick ease forward
4. Rudder neutral, after rotation has stopped
5. Wing Flaps UP
6. Elevator pull cautiously

Bring airplane from descent into level flight position. Do not exceed maximum permissible speed (V_{NE})

3.3.6. Landing with Defective Tire on Main Landing Gear

1. Final approach with wing flaps in landing position.
2. Land airplane on the side of runway opposite to the side with the defective tire to compensate for change in direction which is to be expected during final rolling.
3. Land with wing slightly tipped in the direction of the non-defective tire. To increase the maneuverability during rolling, the nose-wheel should be brought to the ground as soon as possible after touch-down.
4. To ease the load on the defective tire, the aileron should be fully applied in the direction of the non-defective tire.

3.3.7. [Intentionally left blank]

3.3.8. Gliding

- | | | |
|----|---|----------------------------|
| 1. | Wing Flaps | T/O |
| 2. | Airspeed at 1653 lbs (750 kg) (V_{IAS}) | 73 kts / 84 mph / 135 km/h |
| 3. | Glide Ratio 14, which means at
1000 ft/305m above ground, and with no
wind the distance of glide is
2.3 NM (4.25 km) | |

NOTE

The glide distance from 1000 ft altitude increases for each 10 kts tail wind by 1968 ft (0.6 km).
The glide distance from 1000 ft altitude decreases for each 10 kts head wind by 2296 ft (0.7 km).

3.3.9. Electrical Power Failure**a) Total Electrical Power Failure**

- | | | |
|----|-----------------------------------|----------------------------------|
| 1. | Battery Circuit Breaker | If tripped, reset |
| 2. | Master Switch (Generator/Battery) | check ON |
| 3. | If Unsuccessful | Land at nearest suitable airport |

b) Generator Failure

GEN. Annunciator Illuminated

- | | | |
|----|---|--|
| 1. | Master Switch (Generator) | Cycle Generator Master Switch OFF - ON |
| 2. | Generator Circuit Breaker | If tripped, reset |
| 3. | Generator CONTROL Circuit Breaker | If tripped, reset |
| 4. | If Generator can not be brought on-line | Switch OFF all non-flight essential electrical consumers. Monitor Ammeter and Voltmeter. Land at nearest suitable airport. |

NOTE

There are 30 minutes of battery life remaining at a discharge load of 20 amperes.

c) Low Voltage Indication (needle in yellow Arc)**I. LOW VOLTAGE INDICATION (NEEDLE IN YELLOW ARC) WHILE AIRPLANE ON GROUND**

1. Propeller RPM Increase RPM until needle is in the Green Arc.
This should occur before exceeding 1350 RPM.
2. Non-flight essential electrical consumers Switch OFF consumers until needle is in the Green Arc.
3. If needle remains in the yellow arc and the ammeter is indicating to the left of centre (discharge) Discontinue any planned flight activity

II. LOW VOLTAGE INDICATION (NEEDLE IN YELLOW ARC) DURING FLIGHT

1. All non-flight essential electrical consumers Switch OFF
2. If needle is remaining in the yellow arc and the ammeter is indicating to the left of centre (discharge): Generator Failure: Refer to paragraph 3.3.9 (b)

III. LOW VOLTAGE INDICATION (NEEDLE IN YELLOW ARC) DURING LANDING:

1. After landing proceed in accordance with paragraph 3.3.9 (c).

WARNING

If at any time the Voltmeter needle indicates in the red arc, you should land at the nearest suitable airfield and service the aircraft accordingly before continuing the flight.

3.3.10. Flap System Failure

Flap Position Indicator Failure

- visual check of the flap position
- select airspeed within the range of the white arc marked on the airspeed indicator
- check all positions of the flap toggle switch (flap stops are fail-safe)
- modify approach and landing as follows:
 - only UP available:
 - raise approach speed by 5 kts
 - throttle as required
 - flat approach angle
 - only T/O available:
 - normal approach speed
 - throttle as required
 - flat approach angle
 - only LDG available:
 - normal landing

3.3.11. Starter Failure

Starter does not disengage after starting the engine (continuous whining sound audible).

1. Throttle IDLE
 2. Ignition Switch OFF
- discontinue any planned flight

3.3.12 Avionics System Failure

Total Avionic Failure:

1. Check Avionic Master Circuit Breaker If tripped, re-engage and monitor status, If it trips again, land at nearest suitable airport
2. Check Avionic Master Switch Toggle avionic master switch, if avionic system remains off-line, pull avionic master control circuit breaker and land at nearest suitable airport

Radio System Operative, no reception:

1. Microphone Key check for stuck Microphone Key on transceiver display
2. Headphones check, deactivate SQUELCH for a few moments, if SQUELCH not heard, check headset connection

Radio System Operative, transmitting not possible:

1. Selected Frequency check if correct
2. Microphone check, if available use different one (headset)

Problem cannot be resolved: switch transponder (if available) to "COMM FAILURE" code if required by the situation and permitted by applicable national regulations.

3.3.13 Trim System Failure

Stuck Trim:

1. Circuit breaker check, reset if breaker is tripped
2. Rocker switch depress in both directions, wait 5 minutes, try again

NOTE

Full range of travel is available for elevator, but expect forces up to 20 lbs. on control stick.

3. Land at nearest suitable airport

Runaway of Trim:

1. Control Stick Grip stick and maintain control of airplane
2. Trim motor circuit breaker Pull circuit breaker
3. Rocker Switch Check if depressed

If reason for runaway condition is obvious and has been resolved, push in (engage) circuit breaker.

NOTE

Full travel of the elevator trim system will take approximately 10 seconds.

3.3.14 Instrument Panel Lighting Failure

1. Rocker Switch, map light ON
2. Rocker Switch, I-panel lighting Cycle Rocker Switch OFF - ON
3. Dimming Control Turn fully clockwise
4. Internal Lighting Circuit Breaker. If tripped, reset
5. If NOT Successful Use Flashlight

Expect electrical power failure. Ref. 3.3.9

3.3.15 Tachometer failure

Operation at T/O (5 minute) power:

1. Airspeed Do not exceed 110 KIAS

Operation at maximum continuous power:

1. Propeller Speed Control Lever Ensure lever is at least $\frac{1}{2}$ inch (10mm) (measured at slot) aft of full forward position. Engine will now be operating at, or below, maximum continuous power.

NOTE

With propeller speed control lever at least $\frac{1}{2}$ inch (10mm) aft of full forward position, the Max. Permissible Continuous RPM (2260 RPM) cannot be exceeded at any throttle setting and airspeed. However, maximum engine power may not be available.

CHAPTER 4

NORMAL OPERATING PROCEDURES

4.1.	INTRODUCTION	4- 2
4.2.	AIRSPEEDS FOR NORMAL FLIGHT OPERATION	4- 2
4.3.	STRUCTURAL TEMPERATURE INDICATOR	4- 3
4.4.	NORMAL OPERATION CHECKLIST	4- 5
4.4.1.	Preflight Inspection	
	I. In-Cabin Check	4- 5
	II. Walk-Around Check	4- 6
4.4.2.	Before Starting Engine	4- 9
4.4.3.	Starting Engine	4-10
4.4.4.	Before Taxiing	4-11
4.4.5.	Taxiing	4-11
4.4.6.	Before Take-off (Engine Run-up)	4-12
4.4.7.	Take-off	4-13
4.4.8.	Climb	4-14
4.4.9.	Cruise	4-14
4.4.10.	Descent	4-15
4.4.11.	Landing Approach	4-15
4.4.12.	Balked Landing	4-16
4.4.13.	After Landing	4-16
4.4.14.	Engine Shut-down	4-16
4.4.15.	Flight in Rain	4-17

4.1. INTRODUCTION

Chapter 4 provides checklist and amplified procedures for the normal operation. For normal procedures and supplementary information associated with optional systems refer to Chapter 9.

4.2. AIRSPEEDS FOR NORMAL FLIGHT OPERATION

Unless stated otherwise, the following table contains the applicable airspeeds for maximum take-off and landing weight. The airspeeds may also be used for lower flight weights.

TAKE-OFF	VIAS		
	kts	mph	km/h
Climb Speed during normal take-off for 15 m (50 ft) obstacle	57	66	106
Best Rate-of-Climb speed at sea level v_Y (Wing Flaps T/O)	65	75	120
Best Angle-of-Climb speed at sea level v_X (Wing Flaps T/O)	57	66	106

LANDING	VIAS		
	kts	mph	km/h
Approach speed for normal landing. Wing Flaps in landing position	57	66	106
Balked landing climb speed, Wing Flaps in landing position	57	66	106
Maximum demonstrated crosswind speed during take-off and landing	15	17	27

CRUISE	VIAS		
	kts	mph	km/h
Maximum permissible speed in rough air v_{NO}	118	135	218
Maximum permissible speed with full control surface deflections v_A	104	120	193
Maximum permissible speed with Wing Flaps extended v_{FE}	81	93	150

4.3 STRUCTURAL TEMPERATURE INDICATOR

A structural temperature indicator, installed on the spar bridge, indicates when the structural temperature limitation is exceeded (ref. section 2.17). The indicator need only be checked if the OAT exceeds 38° C (100° F).

The indicator is accessed by lifting the flap between the two seatback cushions. The indicator is visible through the cut out in the seat shell backs (ref. fig. 2).

At temperatures below the 55° C (131° F) limit, the indicator appears all red with a faint indication of “55” (° C). At temperatures exceeding the 55° C (131° F) limit, the indicator displays a clearly contrasting red “55” (° C) on a black background (ref. fig.1).

NOTE

At temperatures approaching the limit, the background will progressively darken prior to turning black; this indicates acceptable temperatures.

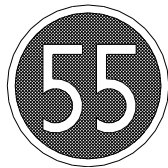

Red “55” on black background indicates that structural temperature limit is exceeded. Flight is prohibited.

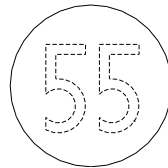

All red indicates that structural temperature is below limit. Flight is permitted.

Figure 1

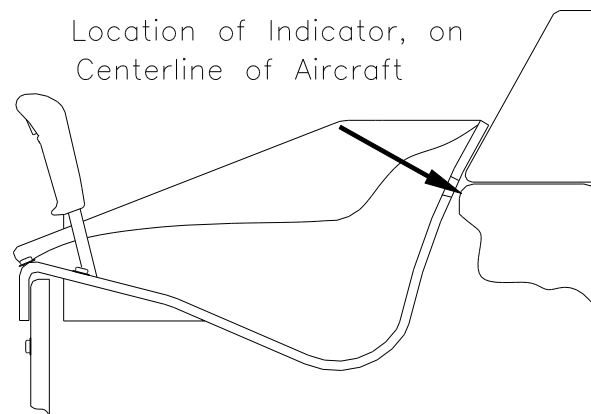

Figure 2

[INTENTIONALLY LEFT BLANK]

4.4. NORMAL OPERATION CHECKLIST

4.4.1. Preflight Inspection

I. In-Cabin Check

- | | |
|---|---|
| 1. Structural Temperature Indicator
(if OAT exceeds 38°C (100° F)) | check that Structural Temperature
does not exceed 55° C (131° F) |
| 2. Airplane Documents | check |
| 3. Flight Control Lock | removed |
| 4. Flight Controls | check for proper direction of
movement |
| 5. Ignition Key | pulled out |
| 6. Carburetor Heat | free, OFF |
| 7. Cabin Heat | free |
| 8. Choke | free, self-resetting |
| 9. Parking Brake | free |
| 10. Throttle | free, IDLE |
| 11. Propeller Speed Control Lever | free, max. RPM |
| 12. Master Switch (Battery) | ON |
| 13. Warning Lights (Gen., Fuel Press., and Canopy) | illuminated |
| 14. Fuel Quantity | sufficient |
| 15. Engine Gauges, Ammeter and Voltmeter | check |
| 16. Circuit Breakers | pressed in |
| 17. Map Light | operational |
| 18. Instrument Lights | operational and dimmable |
| 19. Trim | NEUTRAL |
| 20. Wing Flaps (Indicator- and Flap Actuation) | check, extend and retract fully |
| 21. Trim and Flap Indicator Lights | operational and dimmable |
| 22. Exterior Lights | operational as required |
| 23. Master Switch (Battery) | OFF |
| 24. Foreign Object Inspection | done |
| 25. Emergency Locator Transmitter (ELT): | |
| EBC Model 502 - | ARM |
| EBC Model 102A - | OFF |
| 26. Fire Extinguisher | check |
| 27. Baggage | stowed, baggage net attached |
| 28. Canopy | clean, undamaged |

II. Walk Around Check and Visual Inspection

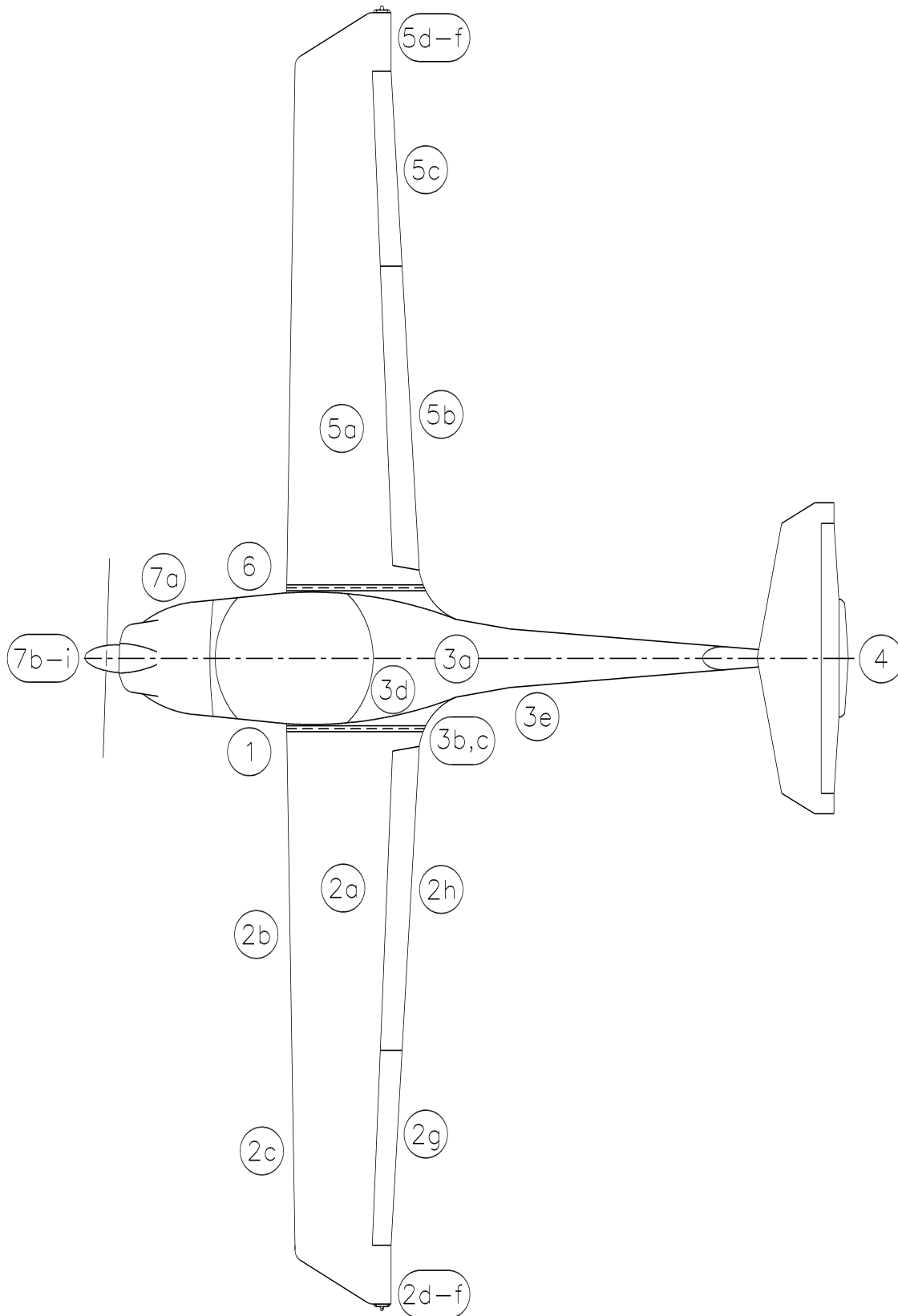

CAUTION

Visually inspect for the following conditions: Defects, contamination, cracks, delaminations, excessive play, insecure or improper mounting and general condition.

Additionally, check the control surfaces for freedom of movement.

CAUTION

Set PARKING brake prior to removing wheel chocks

1. Left Main Landing Gear

- | | |
|-------------------------------------|-------------------|
| a) Landing Gear Strut | visual inspection |
| b) Wheel Fairing | visual inspection |
| c) Tire Pressure (33 psi / 2.3 bar) | check |
| d) Tire, Wheel, Brake | visual inspection |
| e) Wheel Chocks | remove |

2. Left Wing

- | | |
|---|-------------------------|
| a) Entire Wing | visual inspection |
| b) Stall Warning | check (suck on opening) |
| c) Pitot-Static Probe | clean, holes open |
| d) Tie down | remove |
| e) Taxi and Landing Lights | visual inspection |
| f) Wing Tip, Position Lights and Strobe | visual inspection |
| g) Aileron Balancing Weight | visual inspection |
| h) Aileron including Inspection Panel | visual inspection |
| i) Wing Flap including Inspection Panel | visual inspection |

3. Fuselage

- | | |
|------------------|--------------------------------------|
| a) Skin | visual inspection |
| b) Tank Vent | check |
| c) Tank Drain | drain water |
| d) Fuel Quantity | visual inspection (use fuel pipette) |
| e) Antennas | visual inspection |

4. Empennage

- | | |
|-------------------------------------|-------------------|
| a) Stabilizers and Control Surfaces | visual inspection |
| b) Tie down | remove |
| c) Trim Tabs | visual inspection |

5. Right Wing

- | | |
|---|-------------------|
| a) Entire Wing | visual inspection |
| b) Wing Flap including Inspection Panel | visual inspection |
| c) Aileron including Inspection Panel | visual inspection |
| d) Aileron Balancing Weight | visual inspection |
| e) Wing Tip, Position Lights and Strobe | visual inspection |
| f) Tie down | remove |

6. Right Main Landing Gear

- | | |
|-------------------------------------|-------------------|
| a) Landing Gear Strut | visual inspection |
| b) Wheel Fairing | visual inspection |
| c) Tire Pressure (33 psi / 2.3 bar) | check |
| d) Tire, Wheel, Brake | visual inspection |
| e) Wheel Chocks | remove |

7. Nose

- | | |
|-------------------------------------|--|
| a) - Oil | check level by using dip-stick.
min / max range is indicated by flat area
of stick |
| - Coolant | Level must be between dip-stick
markings, refill if required. |
| b) Cowling | visual inspection |
| c) Air Intakes (five) | free |
| d) Propeller | visual inspection, Ground Clearance;
minimum: approx. 25 cm (10 in). |
| e) Propeller Blades | perform Pitch Check by Hand |
| f) Spinner | visual inspection |
| g) Nose Gear | visual inspection, towbar removed |
| h) Wheel Fairing | visual inspection |
| i) Tire Pressure (26 psi / 1.8 bar) | check |
| j) Tire and Wheel | visual inspection |
| k) Wheel Chocks | remove |

4.4.2. Before Starting Engine

CAUTION

Before starting the engine, the canopy must be closed and locked. The red handles must be moved fully forward.

After starting the engine the canopy must be closed and locked and stay closed and locked until the engine is shut down.

During engine operation it is prohibited to enter or exit the airplane.

1.	Preflight Inspection	performed
2.	Pedals	adjust, lock
3.	Passenger Briefing	performed
4.	Safety Belts	fasten
5.	Parking Brake	set
6.	Controls	free
7.	Fuel Shut-off Valve	OPEN
8.	Carburetor Heat	OFF
9.	Throttle	IDLE
10.	Propeller Speed Control Lever	max. RPM
11.	Friction Device of Throttle Quadrant	adjust
12.	Avionics Master Switch	OFF
13.	Master Switch (Battery/Generator)	ON
14.	Generator Warning Light	illuminated
15.	Fuel Pressure Warning Light	illuminated
16.	Exterior Lights	as required
17.	Instrument Panel Lighting	as required
18.	Canopy	Close and Secure
19.	Canopy Locking Warning Light	OFF

NOTE

Under certain circumstances, activation of the fuel pressure warning light might take as long as 10 minutes after shutting down the engine or switching off the electric fuel pump.

4.4.3. Starting Engine**NOTE**

Extreme low temperatures require that the engine be preheated prior to engine start. Satisfactory engine starts have been demonstrated at -31°F (-35°C) OAT after a 2 hour preheat with the Tanis TAS100-27 preheat system.

- | | | |
|----|-----------------------------|-------------------------------------|
| 1. | Electric Fuel Pump | ON (noise of pump audible) |
| 2. | Fuel Pressure Warning Light | OFF |
| 3. | Throttle - Cold Start | IDLE |
| | - Warm Engine | approximately 3/4 in (2 cm) forward |
| 4. | Choke - Cold Start | ON, fully pulled and hold |
| | - Warm Engine | OFF |
| 5. | Toe Brakes | Hold |
| 6. | Propeller Area | Clear |

WARNING

Ensure that propeller area is clear!

- | | | |
|----|--------------|-------|
| 7. | Ignition Key | START |
|----|--------------|-------|

NOTE

During extreme cold weather starts, hold the choke on until the engine starts to warm up.

- | | | |
|-----|--------------|---|
| 8. | Choke | OFF |
| 9. | Throttle | maximum 1500 RPM |
| 10. | Oil Pressure | within green range after
maximum of 10 seconds |

CAUTION

If Oil Pressure is below 12 psi (0.8 bar) shut down engine immediately (max. 10 seconds delay).

NOTE

Oil Pressure may advance to the yellow arc until Oil Temp. reaches normal operating temperatures.

NOTE

Activate starter for max. 10 sec. only, followed by a cooling period of 2 min.

- | | | |
|-----|-------------------------|-------------|
| 11. | Generator Warning Light | OFF |
| 12. | Exterior Lights | as required |
| 13. | Electric Fuel Pump | OFF |

4.4.4. Before Taxiing

- | | | |
|----|--|---|
| 1. | Avionics Master Switch | ON |
| 2. | Flight Instruments and Avionics | set |
| 3. | Engine Gauges | check |
| 4. | Voltmeter | check, ensure needle is in the green arc. Increase RPM to achieve or turn OFF non-flight essential electrical consumers |
| 5. | Warning Lights (Gen., Fuel Press., Canopy) | push to test |
| 6. | Parking Brake | release |

CAUTION

Warm-up engine to a minimum Oil Temperature of 122° F (50° C) at 1100 to 1500 RPM (also possible during taxi).

4.4.5. Taxiing

- | | | |
|----|---------------------------------|-------|
| 1. | Brake | check |
| 2. | Direction Control | check |
| 3. | Flight Instruments and Avionics | check |
| 4. | Compass | check |

CAUTION

At high Propeller RPM the propeller may be damaged by loose sand, gravel or water.

4.4.6. Before Take-off (Engine Run-up)

NOTE

For OAT's less than -5° F (-20° C) turn cabin heat on for at least 10 minutes prior to take-off.

- | | | |
|-----|-------------------------------|---|
| 1. | Toe Brakes | hold |
| 2. | Safety Belts | fastened |
| 3. | Canopy | closed and locked |
| 4. | Fuel Pressure Warning Light | OFF (If light illuminates, maintenance action is required and flight should not be initiated) |
| 5. | Fuel Shut-off Valve | check OPEN |
| 6. | Fuel Quantity Indicator | check |
| 7. | Engine Gauges | within green range |
| 8. | Trim | NEUTRAL |
| 9. | Controls | free |
| 10. | Throttle | 1700-1800 RPM |
| 11. | Propeller Speed Control Lever | Cycle 3 times
(RPM drop: 50 - 250 RPM) |
| 12. | Ignition Switch | Cycle L - BOTH - R - BOTH
(Max. RPM drop: 150 RPM)
(Max. RPM difference (L/R): 50 RPM)
(Min. RPM difference (L/R): none, but RPM drop <u>must</u> be noticeable) |
| 13. | Throttle | 1500 RPM |
| 14. | Carburetor Heat | ON
RPM drop: max. 50 RPM; |
| 15. | Throttle | IDLE |
| 16. | Carburetor Heat | OFF |
| 17. | Circuit Breakers | check pressed IN |
| 18. | Electric Fuel Pump | ON |
| 19. | Wing Flaps | T/O |
| 20. | Parking Brake | release |

4.4.7. Take-off

- | | |
|---------------------------------------|----------------------|
| 1. Electric Fuel Pump | check ON |
| 2. Master Switch (Battery/Generator) | check ON |
| 3. Ignition Switch | check BOTH |
| 4. Carburetor Heat | check OFF |
| 5. Wing Flaps | check T/O |
| 6. Propeller Speed Control Lever | check max. RPM |
| 7. Throttle | FULL |
| Check RPM | 2260 RPM to 2385 RPM |
| 8. Elevator - at beginning of rolling | NEUTRAL |
| 9. Directional Control | maintain with rudder |

NOTE

In crosswind conditions, directional control can be enhanced by using the single wheel brakes. Note that using the brakes for directional control increases the take-off roll distance.

- | | |
|-------------------------------|----------------------------|
| 10. Rotate (V_{IAS}) | 51 kts / 59 mph / 95 km/h |
| 11. Climb Speed (V_{IAS}) | 57 kts / 66 mph / 106 km/h |

CAUTION

For the shortest possible take-off distance to clear a 15 m (50 ft) obstacle:

- | | |
|-----------------------------------|--|
| Lift-off Speed (V_{IAS}) | 54 kts / 62 mph / 100 km/h |
| Climb Speed (V_{IAS}) | 57 kts / 66 mph / 106 km/h |
| 12. Propeller Speed Control Lever | 2260 RPM
(after reaching safe height) |
| 13. Electric Fuel Pump | OFF |

NOTE

In order to avoid excessive noise, the propeller speed should be reduced to 2260 RPM as soon as a safe flight altitude has been reached.

4.4.8. Climb

- | | | |
|----|-------------------------------|----------------------------|
| 1. | Propeller Speed Control Lever | 2260 RPM |
| 2. | Throttle | FULL |
| 3. | Engine Gauges | within green range |
| 4. | Wing Flaps | T/O |
| 5. | Airspeed | 65 kts / 75 mph / 120 km/h |
| 6. | Trim | adjust |

NOTE

The best rate of climb speed decreases with increasing altitude.

NOTE

Electric fuel pump ON above 13000 ft.

Altitude	Speeds [V _{IAS}]					
	flaps T/O			flaps UP		
	feet	kts	mph	km/h	kts	mph
0 - 4000	65	75	120	69	79	128
4000 - 7000	63	73	117	65	75	120
7000 - 10000	62	71	115	—	—	—
above 10000	59	68	110	—	—	—

4.4.9. Cruise

- | | | |
|----|-------------------------------|-----------------|
| 1. | Throttle | as required |
| 2. | Propeller Speed Control Lever | 1700 - 2260 RPM |

NOTE

For favorable manifold pressure/RPM combinations refer to Chapter 5.

NOTE

Electric fuel pump ON above 13000 ft.

- | | | |
|----|---------------|-------------|
| 3. | Wing Flaps | UP |
| 4. | Trim | as required |
| 5. | Engine Gauges | check |

4.4.10. Descent

- | | | |
|----|---------------------------------|-----------------|
| 1. | Flight Instruments and Avionics | adjust |
| 2. | Throttle | as required |
| 3. | Propeller Speed Control Lever | 1700 - 2260 RPM |
| 4. | Carburetor Heat | as required |

NOTE

To achieve a fast descent:

- | | |
|-------------------------------|----------|
| Propeller Speed Control Lever | 2260 RPM |
| Throttle | IDLE |
| Carburetor Heat | ON |

NOTE

Carburetor icing can be recognized by a drop in the engine RPM and/or a loss of manifold pressure and/or irregular running of the engine without a change in the throttle control position, the choke position, the propeller setting, or the altitude. If carburetor icing is suspected, leave the carburetor heat on.

- | | |
|-----------------|------------------------------|
| Carburetor Heat | OFF as required |
| Wing Flaps | UP |
| Airspeed | 118 kts / 135 mph / 218 km/h |

4.4.11. Landing Approach

- | | | |
|----|-----------------------------------|-------------|
| 1. | Seat Belts | fastened |
| 2. | Electric Fuel Pump | ON |
| 3. | Lights | as required |
| 4. | Master Switch (Battery/Generator) | check ON |
| 5. | Ignition Switch | check BOTH |
| 6. | Carburetor Heat | ON |

NOTE

Carburetor icing can be recognized by a drop in the engine RPM and/or a loss of manifold pressure and/or irregular running of the engine without a change in the throttle control position, the choke position, the propeller setting, or the altitude. If carburetor icing is suspected, leave the carburetor heat on.

7.	Carburetor Heat	OFF as required
8.	Throttle	as required
9.	Airspeed	max. 81 kts / 93 mph / 150 km/h
10.	Wing Flaps	T/O
11.	Trim	as required
12.	Propeller Speed Control Lever	max. RPM
13.	Wing Flaps	LDG
14.	Approach Speed	57 kts / 66 mph / 106 km/h

CAUTION

For strong headwind, crosswind, danger of wind-shear or turbulence, a higher approach speed should be selected.

4.4.12. Balked Landing

1.	Propeller Speed Control Lever	max. RPM
2.	Throttle	FULL
3.	Carburetor Heat	OFF
4.	Wing Flaps	T/O
5.	Airspeed	57 kts / 66 mph / 106 km/h

4.4.13. After Landing

1.	Throttle	as required
2.	Wing Flaps	UP
3.	Carburetor Heat	OFF
4.	Exterior Lights	as required
5.	Electric Fuel Pump	OFF

4.4.14. Engine Shut-down

- | | | |
|----|----------------------------|---|
| 1. | Throttle | IDLE |
| 2. | Parking Brake | set |
| 3. | ELT | Check (by listening to
121.5 MHZ for signal) |
| 4. | Avionics Master Switch | OFF |
| 5. | Electric Consumers | OFF |
| 6. | Ignition Switch | OFF |
| 7. | Instrument Panel Lighting | OFF |
| 8. | Master Switch (Battery) | OFF |
| 9. | Tie Downs and Wheel Chocks | as required |

NOTE

In case of post ignition due to hot weather conditions, the ignition should be switched on, choke pulled and after approximately 3 seconds, ignition should be turned off again.

4.4.15. Flight in Rain**NOTE**

Flight performance might be reduced, especially for the T/O-distance and the maximum horizontal air speed. The influence on flight characteristics of the airplane is negligible. Flights through heavy rain should be avoided due to the reduced visibility.

CHAPTER 5

PERFORMANCE

5.1	INTRODUCTION	5- 2
5.2	USE OF PERFORMANCE TABLES AND DIAGRAMS	5- 2
5.3	PERFORMANCE TABLES AND DIAGRAMS	5- 3
5.3.1	Figure 5.1: Airspeed Calibration	5- 3
5.3.2	Figure 5.2: Cruising Performance	5- 4
5.3.3	Figure 5.3: Stall Speeds	5- 5
5.3.4	Figure 5.4: Wind Data	5- 6
5.3.5	Figure 5.5: Take-Off Distances	5- 7
5.3.6	Figure 5.6: Climb Performance / Service Ceiling	5- 9
5.3.7	[INTENTIONALLY LEFT BLANK]	5-10
5.3.8	Figure 5.8: Cruising Speed (True Airspeed)	5-11
5.3.9	Figure 5.9: Maximum Flight Duration	5-12
5.3.10	Figure 5.10: Climb Performance during Balked Landing	5-13
5.3.11	Landing Distances	5-14
5.4	NOISE DATA	5-15

5.1. INTRODUCTION

The performance tables and diagrams on the following pages have been prepared to illustrate the performance you may expect from your airplane as well as to assist you in precise flight planning. The data presented in these tables and diagrams has been derived from test-flights using an airplane and engine in good operating condition, and was corrected to standard atmospheric conditions [59° F (15° C) and 29.92 in. Hg (1013.25 mbar) at sea level].

The performance tables do not take into account the expertise of the pilot or the maintenance condition of the airplane. The performance illustrated in the tables can be achieved if the indicated procedures are followed and the airplane is in good maintenance condition.

Note that the flight duration data does not include a fuel reserve. The fuel consumption during cruise is based on propeller RPM and manifold pressure settings. Some undefined variables such as the operating condition of the engine, contamination of the aircrafts surface, or turbulence could have influences on flight distance and flight duration. For this reason, it is of utmost importance that all available data is used when calculating the required amount of fuel for a flight.

For flight operation without wheel fairings the resulting performance variations is given in %.

5.2. USE OF PERFORMANCE TABLES AND DIAGRAMS

The performance data is shown in the form of tables and diagrams to illustrate the influence of the different variables. These tables contain sufficiently detailed information to plan any flight with the necessary precision and safety on the conservative side.

5.3. PERFORMANCE TABLE AND DIAGRAMS

5.3.1. Figure 5.1: Airspeed System Calibration

Assumes zero indicator error

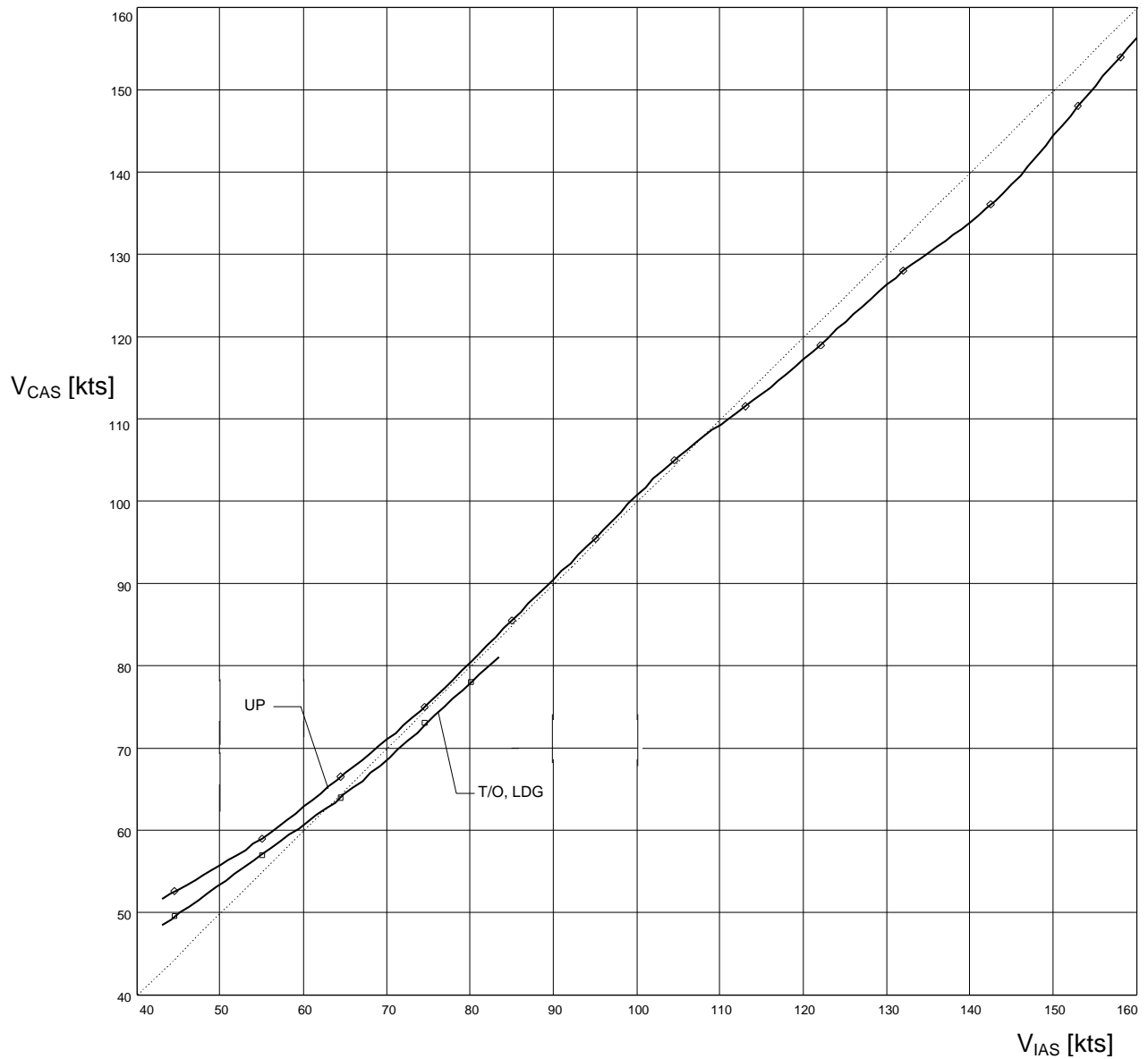

Example: VIAS = 93 kts equals VCAS = 95 kts.

5.3.2. Figure 5.2: Cruising Performance

Pressure altitude		Standard Temp.		Engine power in % of maximum continuous power								
				55%				65%				
				Rpm X100	MP In.Hg	Fuel Flow		Rpm X100	MP In.Hg	Fuel Flow		
L/hr	Gal/hr	L/hr	Gal/hr									
Ft.	M	°C	°F									
0	0	15	59	19	24.7	13.6	3.6	20	25.7	15.6	4.1	
2000	600	11	52	19	24.0	14.4	3.8	20	24.7	16.0	4.2	
4000	1200	7	45	19	23.3	15.6	4.1	21	23.3	16.8	4.4	
6000	1800	3	38	20	22.0	16.8	4.4	22	22.7	19.6	5.2	
8000	2400	-1	31	21	21.0	18.0	4.8	22	21.7	21.2	5.6	
10000	3000	-5	24	22	19.7	19.2	5.1	22.6	20.3*	22.4*	5.9*	
12000	3600	-8	17	22.6	18.0*	20.4*	5.4*					
13000	4000	-11	12	22.6	17.0*	21.5*	5.7*					

Pressure altitude		Standard Temp.		Engine power in % of maximum continuous power								
				75%				85%				
				Rpm X100	MP In.Hg	Fuel Flow		Rpm X100	MP In.Hg	Fuel Flow		
L/hr	Gal/hr	L/hr	Gal/hr									
Ft.	M	°C	°F									
0	0	15	59	21	27.0	18.0	4.8	22.6	27.7	22.0	5.8	
2000	600	11	52	22	25.7	18.4	4.9	22.6	26.7	22.4	5.9	
4000	1200	7	45	22.6	24.3	19.6	5.2	22.6	25.7*	25.2*	6.7*	
6000	1800	3	38	22.6	23.3	23.2	6.1					
8000	2400	-1	31	22.6	22.0*	23.6*	6.2*					

Pressure altitude		Standard Temp.		Maximum Continuous Power				Maximum Take-Off Power				
				Rpm X100	MP In.Hg	Fuel Flow		Rpm X100	MP In.Hg	Fuel Flow		
						L/hr	Gal/hr			L/hr	Gal/hr	
Ft.	M	°C	°F									
0	0	15	59	22.6	28.3	26.0	6.9	23.8	29.7*	30.0	7.9*	
2000	600	11	52	22.6	27.7*	26.8*	7.1*					
4000	1200	7	45	22.6	25.7*	25.2*	6.7*					
6000	1800	3	38									

Fuel flow is given in US-gal.

Data labelled * give a basis for interpolation. These values may not be attained at the stated altitude.

To maintain constant performance at non standard temperature gradient:

Raise manifold pressure by 0.7 in.Hg at ISA + 18° F (10° C)

Lower manifold pressure by 0.7 in.Hg at ISA - 18° F (10° C)

NOTE

To keep engine wear to a minimum, engine operation below 1900 RPM is not recommended.

5.3.3. Figure 5.3: Stall Speeds

Configuration:

Idle, most forward center of gravity, max. weight
(this is the most adverse configuration)

Stall speeds in **kts**

Flaps	Bank Angle							
	0°		30°		45°		60°	
	IAS	CAS	IAS	CAS	IAS	CAS	IAS	CAS
UP	41	50	46	53	55	59	69	70
T/O	39	46	44	49	51	54	63	65
LDG	37	44	41	47	49	52	59	62

Stall speeds in **mph**

Flaps	Bank Angle							
	0°		30°		45°		60°	
	IAS	CAS	IAS	CAS	IAS	CAS	IAS	CAS
UP	47	57	53	62	63	68	79	81
T/O	45	52	51	56	59	62	72	75
LDG	43	50	47	54	56	60	68	72

Stall speeds in **km/h**

Flaps	Bank Angle							
	0°		30°		45°		60°	
	IAS	CAS	IAS	CAS	IAS	CAS	IAS	CAS
UP	76	93	85	99	101	109	127	130
T/O	72	84	81	91	94	100	117	120
LDG	69	81	76	87	91	96	109	115

5.3.4. Figure 5.4: Wind Components

Maximum demonstrated crosswind component: 15 kts (27 km/h)

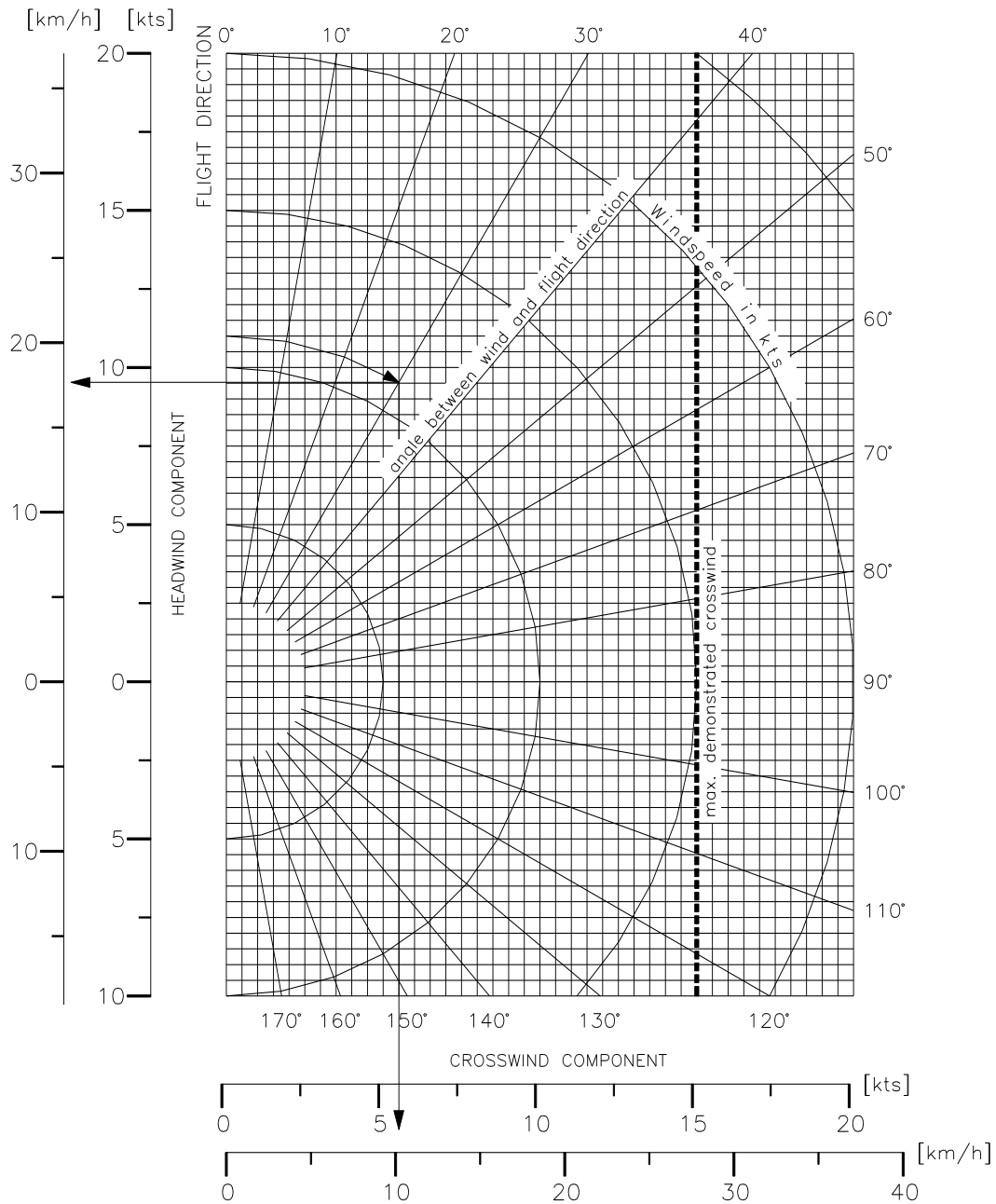

Example:

Wind speed:	11 kts (20 km/h)
Angle between wind direction and flight direction:	30°
Headwind component:	9.5 kts (18 km/h)
Crosswind component:	5.5 kts (10 km/h)

5.3.5. Figure 5.5: Take-off Distance

Conditions:

- maximum take-off power
- lift-off speed 53 KIAS and speed for climb over obstacle 57 KIAS
- level runway, paved
- Wing Flaps in Take-Off Position (T/O)

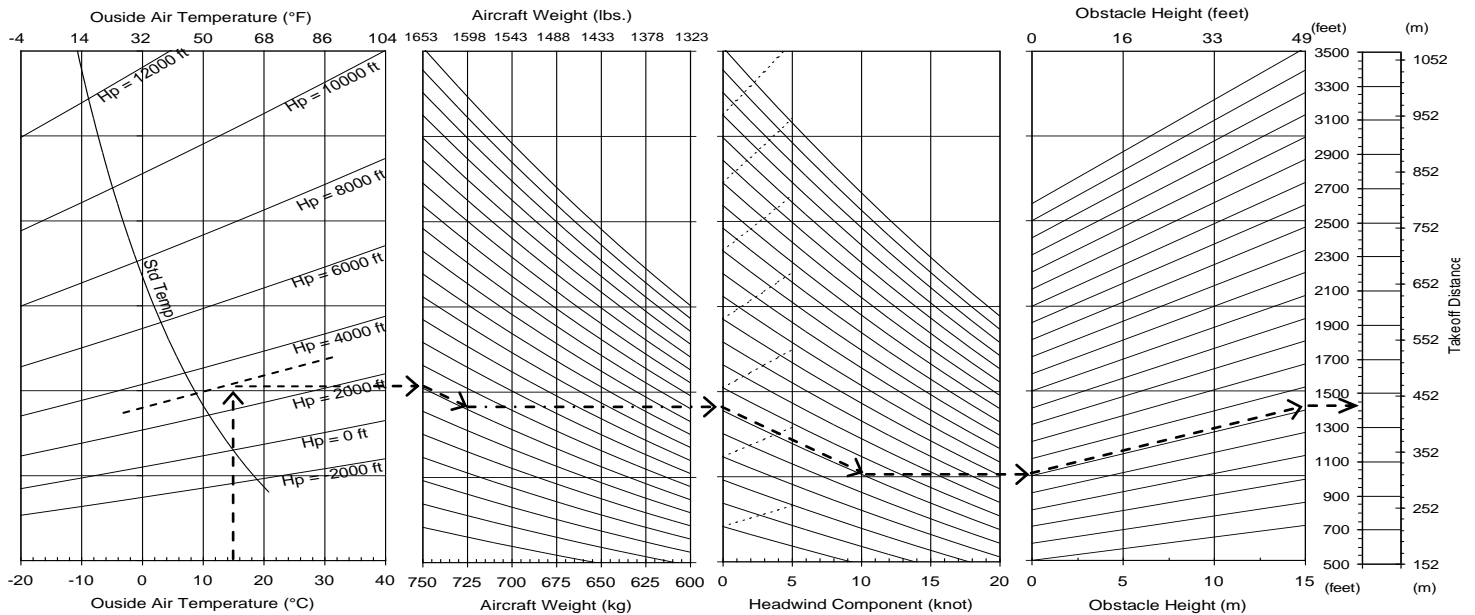

Example:

- Pressure altitude: 3000 ft
- Outside temperature: 15° C (59° F)
- Weight : 1598 lbs (725 kg)
- Headwind: 10 kts

Result:

- Take-off roll distance: 1025ft (312.4 m)
- Take-off distance to clear a 15 m (50 ft) obstacle: 1425 ft (434.3 m)

NOTE

Poor maintenance condition of the airplane, deviation from the given procedures as well as unfavourable outside conditions (high temperature, rain, unfavourable wind conditions, including cross-wind) could increase the take-off distance considerably.

For take-off from dry, short-cut grass covered runways, the following corrections must be taken into account, compared to paved runways:

- Grass up to 5cm (2in) deep: 10% increase in take-off roll distance;
- Grass 5 to 10cm (2 to 4in) deep: 15% increase in take-off roll distance;
- Grass deeper than 10cm (4in): 25% increase in take-off roll distance.

On wet soft grass covered runways with grass deeper than 10cm (4in), the take-off roll distance might be increased by as much as 40%.

This information is provided for guidance purposes only and has not been demonstrated.

The dashed lines in the above diagram (wind component) represent tailwind.

5.3.6. Figure 5.6 : Climb Performance / Service Ceiling

Service Ceiling (in standard conditions): 17600 ft (5365 m)
 Best Rate-of-Climb Speed with Wing Flaps in Take-Off Position (T/O): 65 kts / 75 mph / 120 km/h

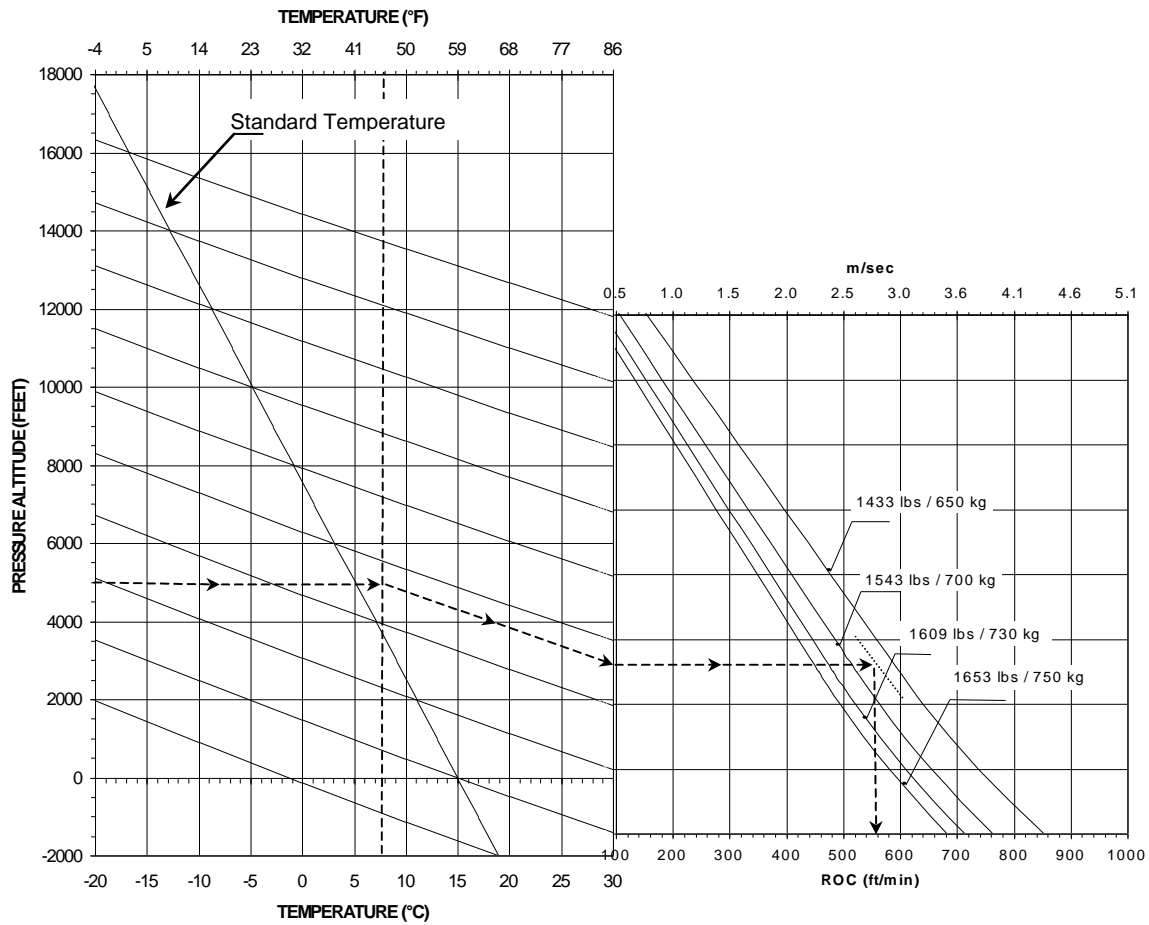

Example: Pressure Altitude: 5000 ft (1524 m)
 OAT: 46° F (8° C)
 Weight : 1477 lbs (670 kg)
Result: Climb performance: 554 ft/min (2.82 m/s)

CAUTION

In case of operation without wheel fairings the climb performance is reduced by approximately 3%.

5.3.7. [INTENTIONALLY LEFT BLANK]

[INTENTIONALLY LEFT BLANK]

5.3.8. Figure 5.8: Cruising Speed (True Airspeed)

Diagram for true airspeed (TAS) calculation at selected power level.

Flight mass 750 kg (1653 lbs) and Flaps UP.

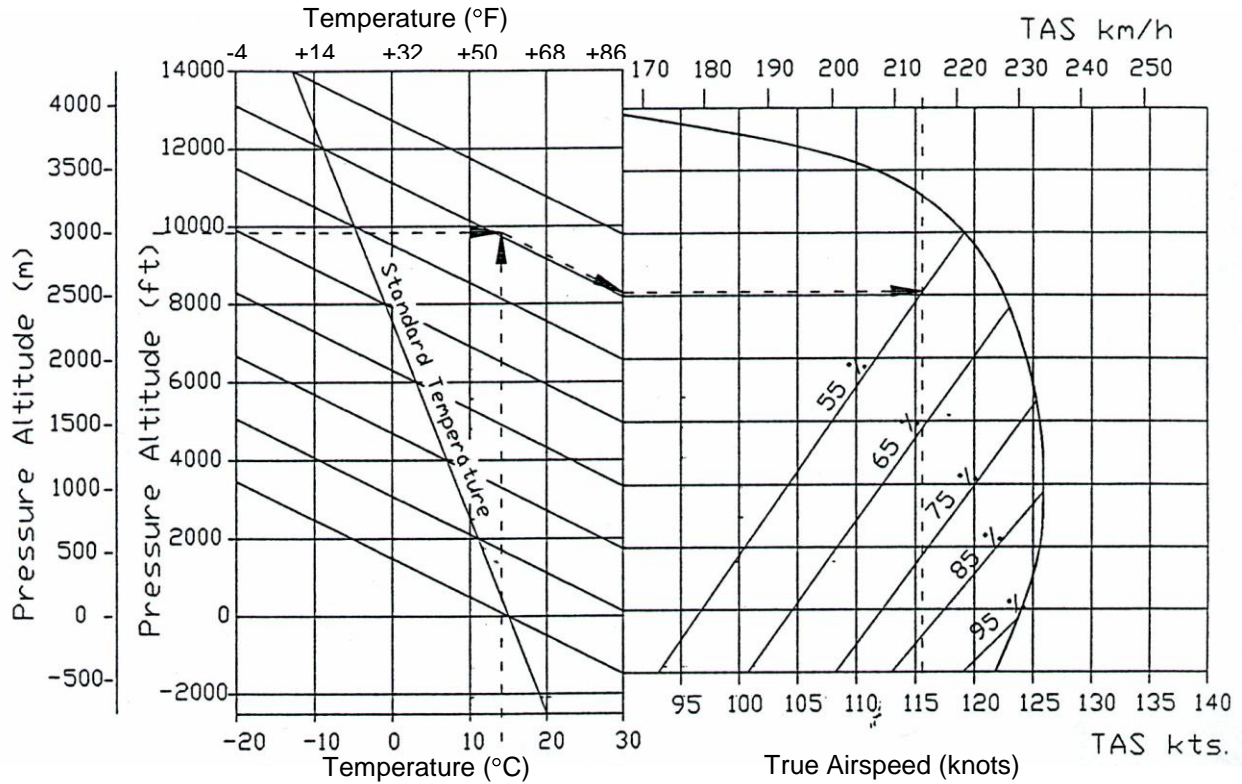

Example: Pressure altitude: 9500 ft
 Temperature: 57° F (14° C)
 power setting: 55 %

Result: True airspeed (TAS): 116 kts (215 km/h)

CAUTION

In case of operation without wheel fairings the maximum cruising speed is reduced by approximately 5%.

5.3.9. Figure 5.9: Maximum Flight Duration

Diagram for calculation of the maximum flight duration depending on fuel availability.

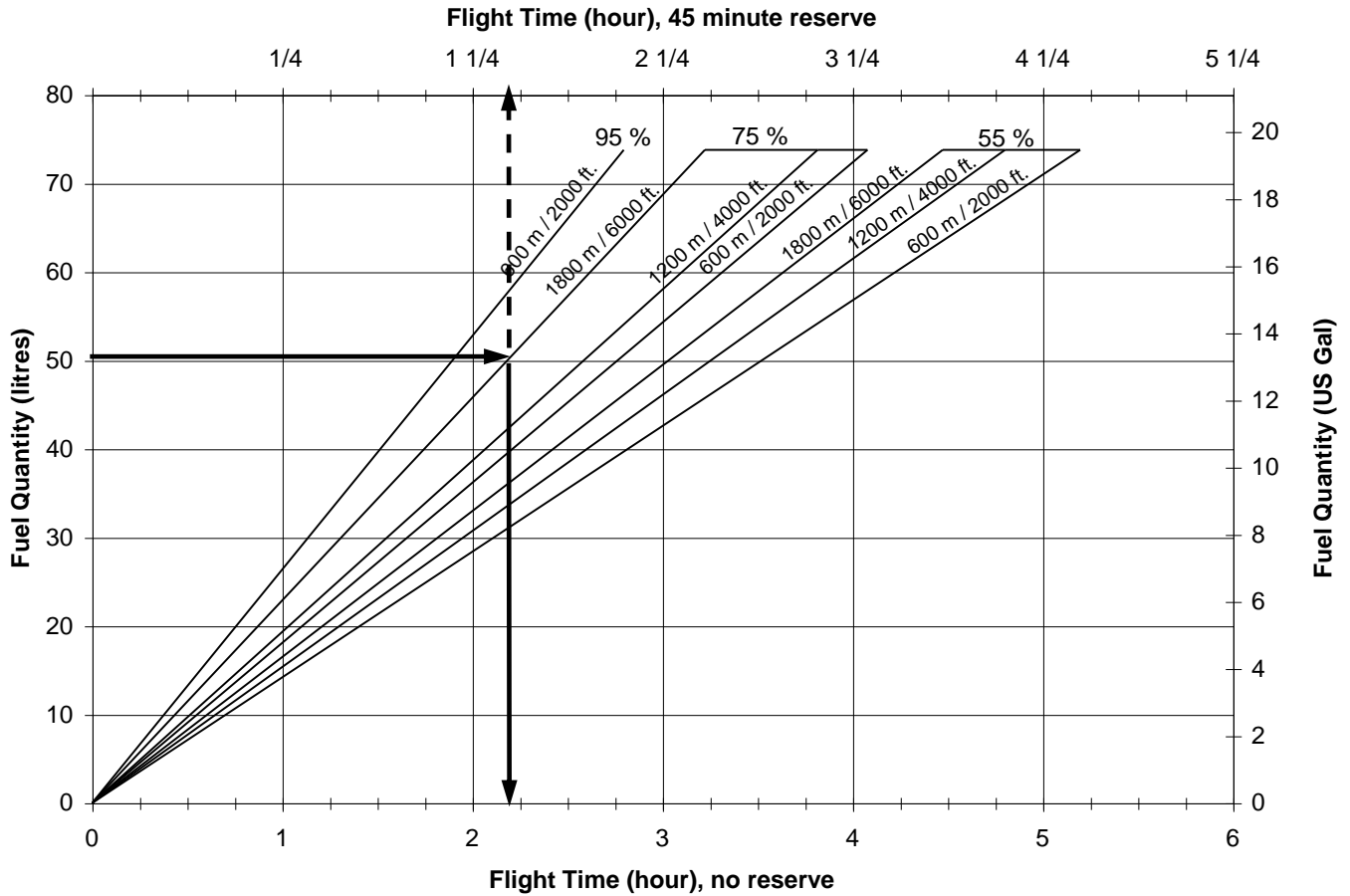

Example: Fuel quantity: 13.2 US gal (50 liters)
 Pressure Altitude: 6000 ft
 Power Setting: 75%

Result: Possible flight time without reserve: 2:11 h:min
 Possible flight time with reserve of 45 mins: 1:26 h:min

5.3.10. Figure 5.10: Climb Performance during Balked Landing

Conditions: Speed = 57 kts / 66 mph / 106 km/h
 Wing Flaps in Landing Position (LDG)
 Weight 750 kg (1653 lbs)
 most forward center of gravity
 max take-off power

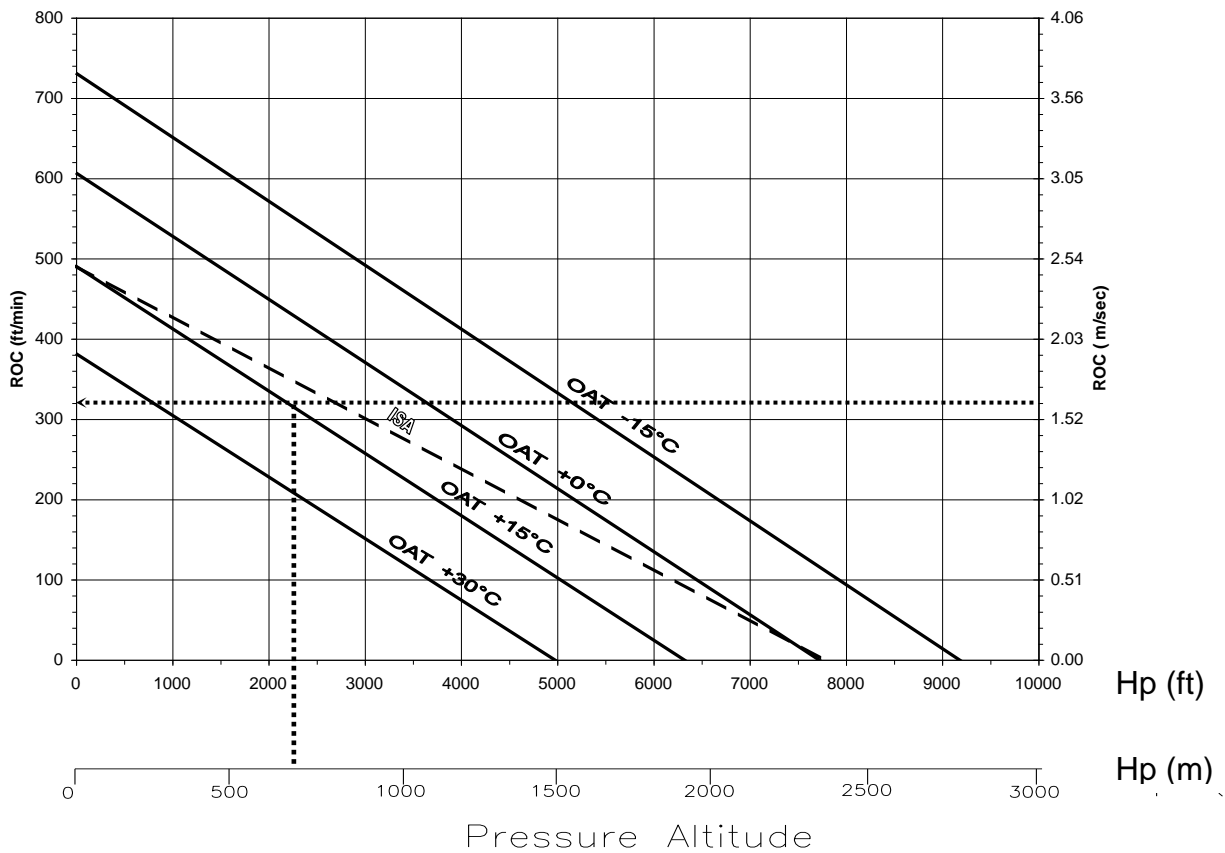

Example: Pressure altitude: 2250 ft (685 m)
 Outside temperature: 59° F (15° C)

Result: Climb performance during balked landing: 320 ft/min. (1.63 m/sec)

CAUTION

In case of operation without wheel fairings the climb performance is reduced by approximately 3%.

5.3.11. Landing Distance

- Conditions:
- Throttle: Idle
 - Maximum T/O Weight
 - Propeller Speed Control Lever: max RPM
 - Approach Speed 57 kts / 66 mph / 106 km/h
 - Level Runway, paved
 - Wing Flaps in Landing position (LDG)
 - Standard Setting, MSL

Landing distance over a 15 m (50 ft) obstacle: approx. 1532 ft (467 m)

Landing roll distance: approx. 790 ft (241 m)

Figure 5.11: Landing and Rolling Distances for Heights Above MSL

Height above MSL	ft. (m)	0 (0)	1000 (305)	2000 (610)	3000 (914)	4000 (1219)	5000 (1524)
Landing Distance	ft. (m)	1532 (467)	1593 (486)	1653 (504)	1714 (522)	1775 (541)	1836 (560)
Landing Roll Distance	ft. (m)	790 (241)	813 (248)	837 (255)	862 (263)	889 (271)	916 (279)

NOTE

Poor maintenance condition of the airplane, deviation from the given procedures as well as unfavourable outside conditions (high temperature, rain, unfavourable wind conditions, including cross-wind) could increase the landing distance considerably.

For landings on dry, short-cut grass covered runways, the following corrections must be taken into account, compared to paved runways:

- Grass up to 5cm (2in) deep: 5% increase in landing roll distance;
- Grass 5 to 10cm (2 to 4in) deep: 15% increase in landing roll distance;
- Grass deeper than 10cm (4in): 25% increase in landing roll distance.

On wet soft grass covered runways with grass deeper than 10cm (4in), the landing roll distance might be increased by as much as 40%.

This information is provided for guidance purposes only and has not been demonstrated.

5.4 NOISE DATA

- | | | |
|----|---|-------------|
| a) | Noise limit according to FAR 36, Appendix G: | 75.0 dB (A) |
| | Noise value measured: | 63.8 dB (A) |
| b) | Noise limit according to ICAO Annex 16, Chapter 10: | 79.1 dB (A) |
| | Noise value measured: | 71.7 dB (A) |

CHAPTER 6

WEIGHT AND BALANCE / EQUIPMENT LIST

6.1 INTRODUCTION	6-2
6.2 AIRPLANE WEIGHING	6-3
- Figure 6.1 Weighing Report	6-4
6.3 WEIGHT AND BALANCE REPORT	6-5
- Figure 6.2 Weight & Balance Report	6-6
6.4 FLIGHT-WEIGHT AND CENTER OF GRAVITY	6-7
- Figure 6.3 Weight & Balance Diagram	6-8
- Figure 6.4 Calculation of Loading Condition	6-9
- Figure 6.5 Permissible Center of Gravity Range and permissible Flight Weight-Moment	6-10
6.5 EQUIPMENT LIST	6-11

AIRCRAFT SPECIFIC WEIGHT AND BALANCE DOCUMENTS (ENCLOSED AT THE END OF THIS CHAPTER)

6.1. INTRODUCTION

To obtain the performance, flight characteristics and safe operation described in this Flight Manual, the airplane must be operated within the permissible weight and balance envelope as described in Chapter 2. It is the pilot's responsibility to adhere to the weight and balance limitations and to take into consideration the change of the CG position due to fuel consumption.

The procedure for weighing the airplane and calculating the empty weight CG position are given in this Chapter.

The aircraft is weighed when new and should be reweighed in accordance with applicable air regulations. Empty weight and the center of gravity are recorded in a Weighing Report and Weight and Balance Report as illustrated in the samples in figure 6.1 and 6.2. The actual report for the aircraft is at the end of this chapter.

In case of equipment changes, the new weight and empty weight CG position must be determined by calculation or by weighing and must be entered in the Weight & Balance Report. The following pages are sample forms which can be used for airplane weighing, calculation of the empty weight CG position, and for the determination of the useful load.

NOTE

After every repair, painting or change of equipment the new empty weight must be determined as required by applicable air regulations. Weight, empty weight CG position and useful load must be entered in the Weight & Balance Report by an authorized person.

6.2. AIRPLANE WEIGHING

Pre-weighing conditions:

- equipment must be in accordance with the airplane equipment list
- brake fluid, lubricant (3.17 US qt / 3 liters), coolant (2.64 US qt / 2,5 liters) and unusable fuel (0.53 US gal./ 2 liters), included

To determine the empty weight and the empty weight CG position, the airplane is to be positioned in the above mentioned pre-weighing condition, with the nose gear and each main gear on a scale. Ensure the aircraft is level longitudinally as illustrated on the weighing report (see figure 6.1).

With the airplane correctly positioned, a plumb line is dropped from the leading edge of each wing at the root rib to the floor, join these two points to determine the reference datum (RD). From this line use a suspended plumb line aligned with each landing gear to measure the distances D_N (nose gear), D_L (left main gear) and D_R (right main gear).

The following formulas apply:

Empty Weight: $W_T = W_N + W_L + W_R \quad \text{lbs [kg]}$

Empty Weight Moment: $M = W_N \times D_N + W_L \times D_L + W_R \times D_R \quad \text{in}\cdot\text{lbs [m}\cdot\text{kg]}$

Empty Weight CG position : $= \frac{\text{Empty Weight Moment}}{\text{Empty Weight}} = \frac{M}{W_T} \quad \text{in [m]}$

CAUTION

Items ahead of RD are considered to have a negative lever arm.

Items aft of RD are considered to have a positive lever arm.

Record the data in the Weighing Report included at the end of this chapter. The following Sample Weighing Report figure 6.1 is for reference only.

Figure 6.1: Sample Weighing Report (Aircraft Specific report at the end of this chapter.)

Model: DA 20/100 S/N: _____ Registration: _____

Data in accordance with TCDS and Flight Manual Reason for Weighing: _____

Reference Datum: Leading edge of wing at root rib

Horizontal reference line: 24" Spirit Level placed on Fuselage Canopy Rail (L or R), supported at front by a 2 1/4" spacer as shown below

Weighing Conditions: including brake fluid, lubricant, coolant and unusable fuel (3.31 lbs/1.5 kg)
Equipment List dated: _____

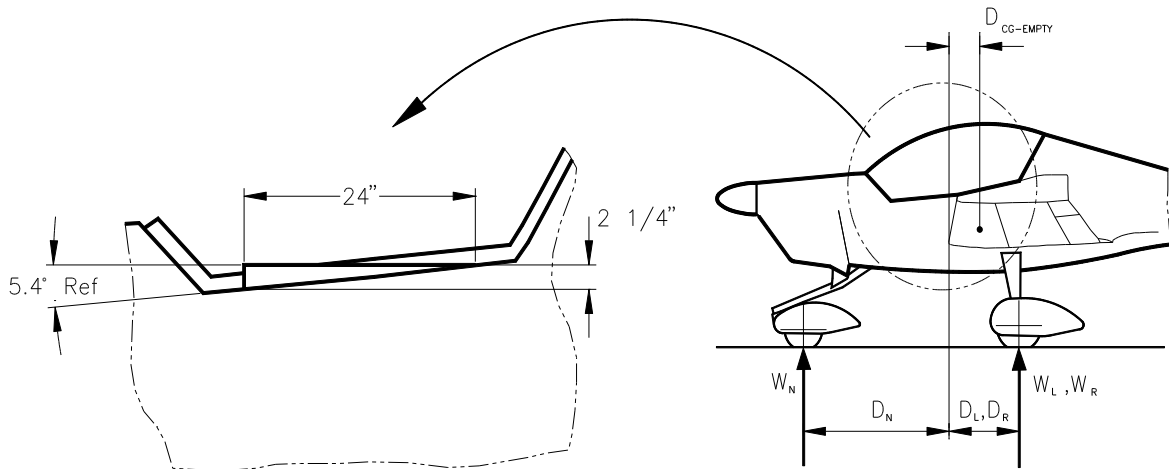

Support	Gross [lbs] ([kg])	Tare [lbs] ([kg])	Net Weight [lbs] ([kg])	Lever Arm [in] ([m])
Nose			$W_N =$	$D_N =$
Main Left			$W_L =$	$D_L =$
Main Right			$W_R =$	$D_R =$
Empty Weight $W_T = W_N + W_L + W_R =$ _____ lbs (kg)				

Empty Weight Moment $M = W_N \times D_N + W_L \times D_L + W_R \times D_R =$ _____ in lbs [m kg]

Empty Weight CG Position $\frac{\text{Empty Weight Moment}}{\text{Empty Weight}} = \frac{M}{W_T} =$ _____ in [m]

(Positive results indicate, that CG is located aft of RD)

Maximum Permissible Useful Load:	Maximum Weight [lbs] ([kg])	+
	Empty Weight [lbs] ([kg])	-
	Max useful Load [lbs] ([kg])	=

Data to be entered into the Flight Manual: see page 6-6

Empty Weight [lbs] ([kg])	Empty- Weight-Moment [in-lbs] ([kg-m])
---------------------------	--

Place / Date	Inspector's Stamp	Inspector's Signature
--------------	-------------------	-----------------------

6.3. WEIGHT AND BALANCE REPORT

The empty weight and Empty Weight CG position data determined prior to delivery of the airplane is the first entry in the Weight and Balance Report. Each change of the installed equipment as well as each repair affecting the empty weight, the CG position of the empty weight or the empty weight moment must be entered in the Weight and Balance Report at the end of this chapter. The following Sample Weight and Balance Report figure 6.2. is for reference only.

Ensure that you are using the latest weight and balance information when performing a weight and balance calculation

figure 6.2: Sample Weight and Balance Report (Aircraft specific report at the end of this chapter)

Model: DA20-A1/100 KATANA



Aircraft Serial No.: []
Registration: []
Issue Date: []

Aircraft Specific Weight and Balance Report

Date	IN OUT		Description of Part or Modification	Changes of Weight						Actual			Signature
				Addition (+)			Subtraction (-)			Empty Weight			
				Weight lbs (kg)	Arm in (m)	Moment in.lbs (kg.m)	Weight lbs (kg)	Arm in (m)	Moment in.lbs (kg.m)	Weight lbs (kg)	Arm in (m)	Moment in.lbs (kg.m)	
			Original										

6.4. FLIGHT WEIGHT AND CENTER OF GRAVITY

The following data enables the pilot to operate the DA 20/100 within the required weight and center of gravity limitations.

The following diagrams,

Figure 6.3 Weight & Balance Diagram

Figure 6.4 Calculation of Loading Condition

Figure 6.5 Permissible Center of Gravity Range
and permissible Flight-Weight-Moment

are to be used for calculations of the flight-weight and the center of gravity as follows:

1. The empty weight and the empty-weight-moment of the airplane should be taken from the weighing report or from the weight & balance report and entered into the form "Calculation of Loading Condition" (figure 6.4) in the columns identified with "Your DA 20".
2. Using the Weight & Balance Diagram (see figure 6.3) determine the moment for each part to be loaded, and enter it in the respective column in figure 6.4.
3. Add the weights and the moments of each column (point 4 and point 6 in figure 6.4) and enter the sum in figure 6.5 "Permissible CG Range and Permissible Flight-Weight-Moment" to check if the values are within the permissible limits of the loading range.

Figure 6.3: Weight & Balance Diagram

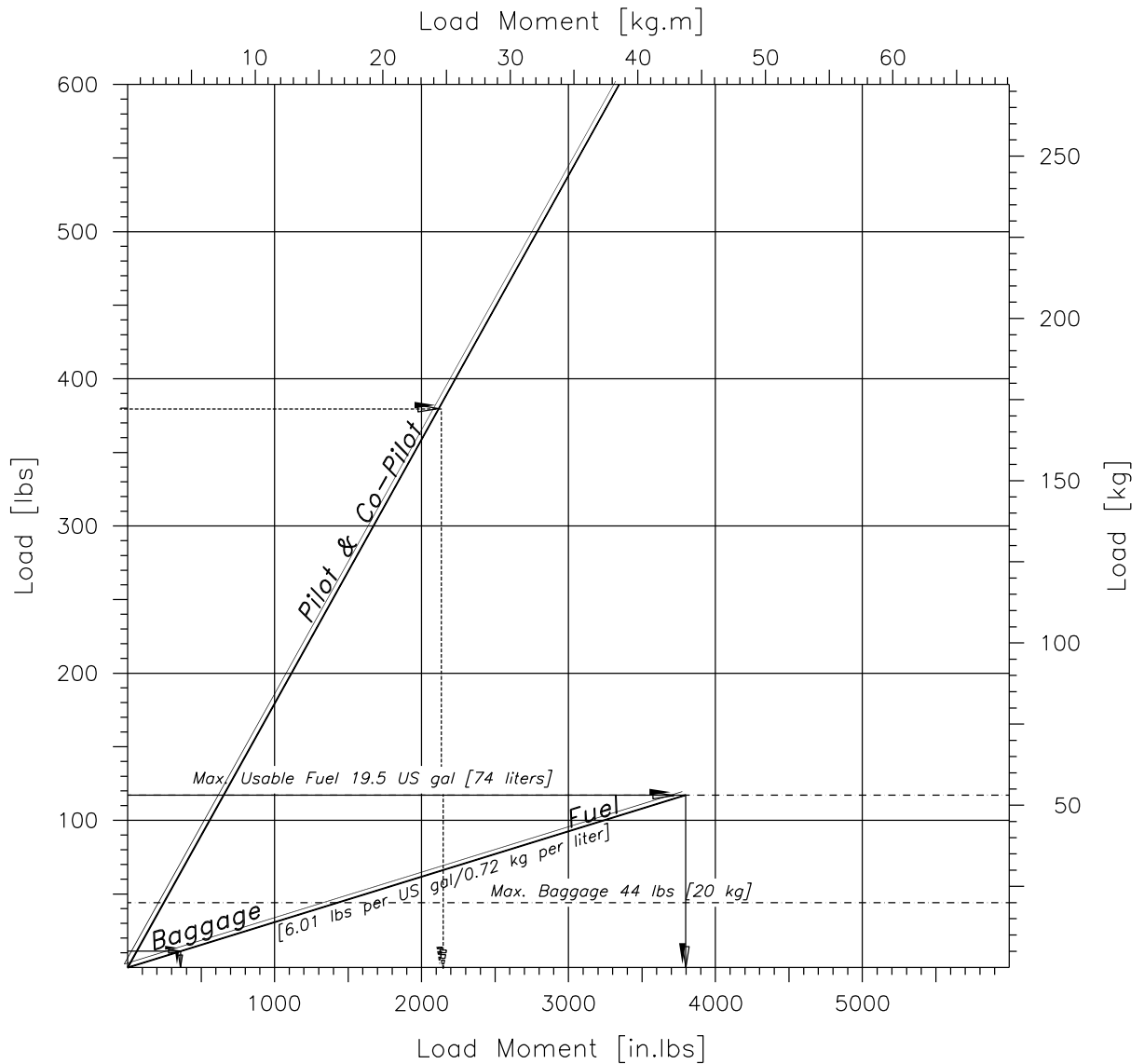

Example: Pilot and Passenger: 380 lbs. (172 kg)

Fuel 19.5 US gal. / 74 liters: 117 lbs. (53 kg)

(6.01 lbs. per US gal./0.72 kg per liter)

Baggage 11lbs. (5 kg)

Result: Moment of Pilot and Passenger: 2139 in.lbs. (24.60 kgm)

Moment of Fuel: 3796 in.lbs. (43.76 kgm)

Moment of Baggage 357 in.lbs. (4.12 kgm)

Figure 6.4: Calculation of Loading Condition

Calculation of the Load Limits	DA 20 (Example)		Your DA 20	
	Weight [lbs]	Moment [in.lbs]	Weight [lbs]	Moment [in.lbs]
	(Weight [kg])	([kgm])	(Weight [kg])	([kgm])
1. Empty Weight (use the data for your airplane recorded in the equipment list, including unusable fuel, lubricant and coolant).	1145 (520)	12880 (148.40)		
2. Pilot and Passenger: Lever Arm: 0.143 m (5.63 in)	380 (172)	2139 (24.60)		
3. Baggage: Lever Arm: 0.824 m (32.44 in)	11 (5)	357 (4.12)		
4. Total Weight and Total Moment with empty fuel tank (sum of 1. - 3.)	1536 (697)	15376 (177.12)		
5. Usable Fuel Load (6.01 lbs. per US gal./0.72 kg per liter) Lever Arm (32.44 in) (0.824 m)	117 (53)	3796 (43.76)		
6. Total Weight and Total Moment, taking fuel into account (sum of 4. and 5.)	1653 (750)	19172 (220.88)		
7. Find the values for the total weight (1536 lbs. and 1653 lbs.) and the total moment (15376 in.lbs. and 19172 in.lbs.) in the center of gravity diagram. Since they are within the limitation range, the loading is permissible.				

Figure 6.5: Permissible Center of Gravity Range and permissible Flight-Weight-Moment

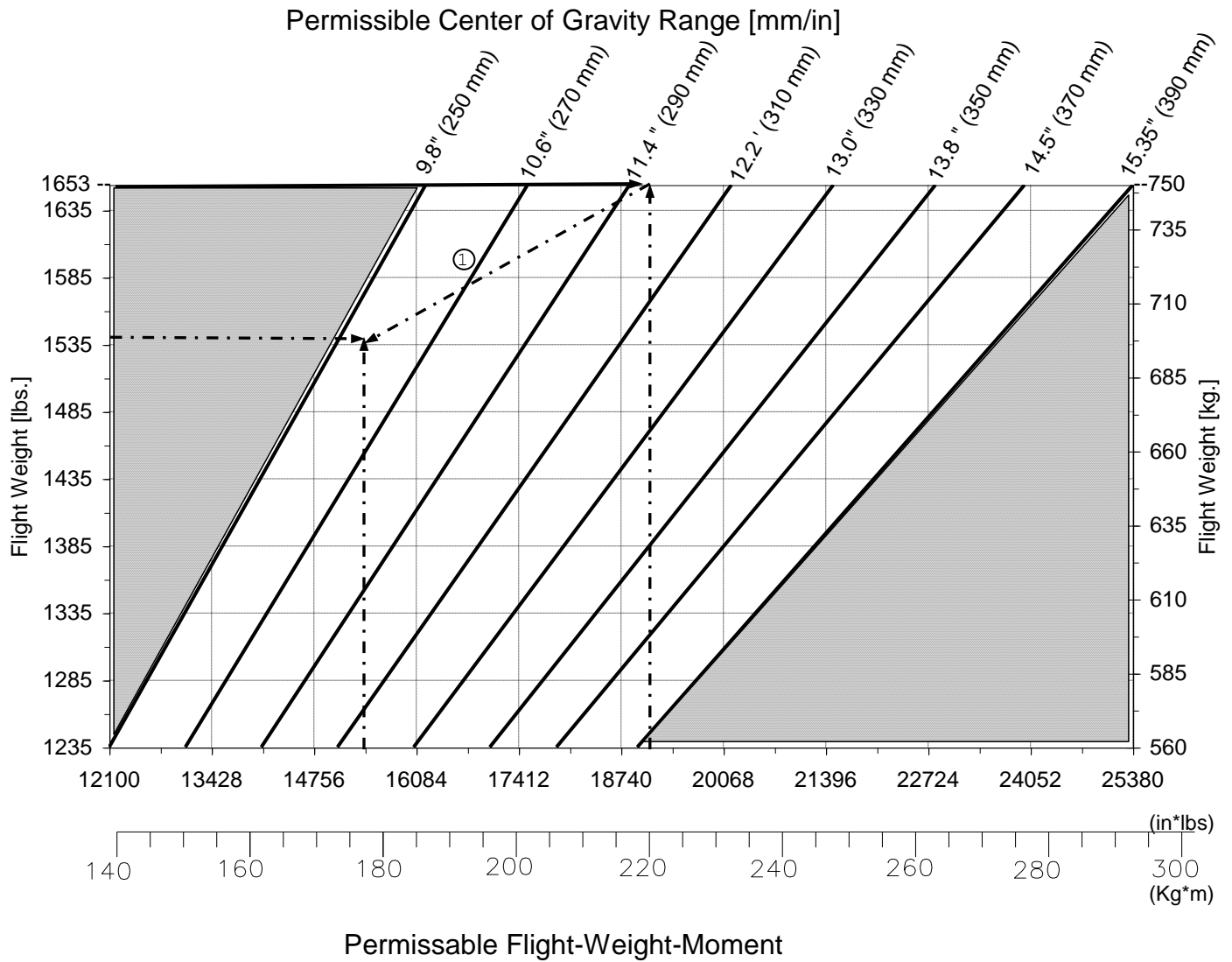

--- DA 20 (Example of page 6-9)

① Changes during flight (due to fuel consumption)

6.5. EQUIPMENT LIST

The following table lists the equipment available for this airplane. An Equipment Record of items installed in your specific airplane is included at the end of this chapter.

The equipment list comprises the following data:

- The item No. containing an alpha character for the equipment group and a sequential number.
- Abbreviations:
 - A** Avionics
 - I** Instruments
 - M** Miscellaneous (any equipment other than avionics or instruments)

Weight and lever arm of the equipment items are shown in the columns "Weight" and "Arm".

NOTE

Additional installation of equipment must be carried out in compliance with the specifications in the Maintenance Manual. The columns "Weight" and "Arm" show the weight and the CG position of the equipment with respect to the reference datum. A positive value shows the distance aft of the reference datum, a negative value shows the distance forward of the reference datum.

Equipment List			
Seq. No.:	Part Description, Manufacturer, Type	Weight [lbs] (kg)	Arm [in] (m)
A 1	ADF King KR87	3.20 (1.45)	-20.5 (-0.521)
A 2	Slaving Amplifier Century 1D755	1.80 (0.82)	+5.5 (+0.140)
A 3	ADF ANTENNA King KA44B	2.80 (1.27)	+38.5 (+9.78)
A 4	GPS / Com King KLX135A	4.4 (1.98)	-20.5 (-0.521)
A 5	DME Antenna King KA60	0.20 (0.09)	+18.0 (+0.457)
A 6	GPS Antenna Garmin GA56	0.25 (0.11)	+16.0 (+0.407)
A 7	GPS Antenna King KA91	0.6 (0.27)	+16.0 (+0.407)
A 8	Marker Beacon Antenna King KA26	0.50 (0.23)	+59.0 (+1.499)
A 9	Transponder Antenna Bendix/King, KA60	0.20 (0.09)	+18.0 (+0.457)
A 10	VHF-AM Antenna Comant CI122	0.50 (0.23)	+43.5 (+1.105)
A 11	Audio Panel King KMA24	1.7 (0.772)	-20.5 (-0.521)
A 12	Audio Panel Terra TMA350D	1.7 (0.772)	-20.5 (-0.521)
A 13	Diplexer Comant CI1125	0.25 (0.11)	-18.0 (-0.457)
A 14	Diplexer Comant CI505	0.20 (0.09)	-18.0 (-0.457)
A 15	DME King KN64	2.60 (1.18)	-20.5 (-0.521)
A 16	Encoder SSD120-20	0.80 (0.363)	-22.5 (-5.71)
A 17	Flux Detector Century 1B495	0.40 (0.18)	+14.0 (+0.356)
A 18	GPS Garmin 155	2.14 (0.97)	-20.5 (-0.521)
A 19	GPS / Com King KLX135	4.4 (1.98)	-20.5 (-0.521)
A 20	ADF Indicator King KI227	0.70 (0.32)	-15.5 (-0.394)

Equipment List			
Seq. No.:	Part Description, Manufacturer, Type	Weight [lbs] (kg)	Arm [in] (m)
A21	Hour Meter Hobbs 85000	0.50 (0.227)	-15.5 (-0.394)
A22	HSI Indicator Century NSD1000	4.60 (2.09)	-16.35 (-0.415)
A23	Nav Indicator King KI208	1.10 (0.499)	-16.35 (-0.415)
A24	Nav Indicator King KI209	1.10 (0.499)	-16.35 (-0.415)
A25	Outside Air Temperature Indicator Davtron 301F	0.50 (0.227)	-15.5 (-0.394)
A26	Intercom PS Engineering PM501	0.53 (0.240)	-15.5 (-0.394)
A27	Nav / Com #1 King KX125	3.88 (1.76)	-20.5 (-0.521)
A28	Nav / Com #2 King KX125	3.88 (1.76)	-20.5 (-0.521)
A29	† Nav / Com #1 King KX155	4.94 (2.24)	-20.5 (-0.521)
A30	† Nav / Com #2 King KX155	4.94 (2.24)	-20.5 (-0.521)
A31	Remote Switch NAT RS16	0.44 (0.20)	-17.0 (-0.432)
A32	Transponder Bendix/King, KT76A	3.00 (1.36)	-20.5 (-0.521)
A33	GPS Garmin, GPS150	2.14 (0.97)	-20.5 (-0.521)
A34	Chronometer Davtron M800B	0.24 (0.11)	-15.5 (-0.394)
A35	Audio Panel King KA134 TSO'd	0.8 (0.36)	-20.5 (-0.521)
A36	GPS King KLN 35A	2.07 (0.94)	-20.5 (-0.521)
A37	*Emergency Locator Transmitter EBC 502	2.75 (1.25)	+44.75 (+1.137)
A38	Emergency Locator Transmitter EBC 102A	2.12 (0.96)	+44.75 (+1.137)

* Not approved for use in all countries; check national regulations.

† Not all serial numbers are approved in all countries; check national regulations. (KX 155 P/N 069-01024-0042 S/N 25000 and above comply with ICAO ANNEX 10. S/N 24999 and below require Mod 16 to comply with ICAO ANNEX 10.)

Equipment List			
Seq. No.:	Part Description, Manufacturer, Type	Weight [lbs] (kg)	Arm [in] (m)
I1	Altimeter United, 5934PD3	0.86 (0.39)	-16.35 (-0.415)
I2	Compass Airpath C2300L4	0.75 (0.34)	-15.0 (-0.381)
I3	Compass IFR 31-12	0.64 (0.290)	-16.35 (-0.415)
I4	Turn Coordinator EGC 1394T100-7Z	1.2 (0.54)	-16.35 (-0.415)
I5	Ammeter VDO,190-031S3	0.18 (0.08)	-16.35 (-0.415)
I6	Cylinder Head Temp. Indicator VDO 20-3910-20-04	0.31 (0.14)	-16.35 (-0.415)
I7	Fuel Quantity Indicator VDO 301-035SB	0.20 (0.09)	-16.35 (-0.415)
I8	Manifold Pressure Indicator Uma 7-100-20	0.29 (0.13)	-16.35 (-0.415)
I9	Oil Pressure Indicator VDO 20-3910-20-03	0.31 (0.14)	-16.35 (-0.415)
I10	Oil Pressure Indicator (Installed by SB DA20-79-08) 20-7930-00-00	0.31 (0.14)	-16.35 (-0.415)
I11	Oil Temperature Indicator VDO 20-3910-20-02	0.31 (0.14)	-16.35 (-0.415)
I12	Directional Gyro R.C.Allen, RCA15AK-2	2.45 (1.11)	-16.35 (-0.415)
I13	Artificial Horizon R.C.Allen, RCA26AK-1	2.43 (1.10)	-16.35 (-0.415)
I14	Airspeed Indicator United, 8000	0.66 (0.30)	-16.35 (-0.415)
I15	Turn and Slip Indicator RCA Allen 56-3BL	1.23 (0.56)	-16.35 (-0.415)
I16	Vertical Speed Indicator United, 7000	0.77 (0.35)	-16.35 (-0.415)
I17	RPM Indicator Superior Labs 1010-12009-11-N00	0.60 (0.27)	-16.35 (-0.415)
I18	Manifold Pressure Indicator Mitchel D1-111-5076	0.29 (0.13)	-16.35 (-0.415)
I19	Artificial Horizon B.F. Goodrich, 5040033943	2.5 (1.14)	-16.35 (-0.415)
I20	Directional Gyro B.F. Goodrich, 5050031927	3.0 (1.34)	-16.35 (-0.415)

Equipment List			
Seq. No.:	Part Description, Manufacturer, Type	Weight [lbs] (kg)	Arm [in] (m)
M1	Wheel Fairing, Main Gear DIAMOND left or right	2.65 (1.20)	+27.56 (+0.700)
M2	Wheel Fairing, Nose Gear DIAMOND	2.65 (1.20)	-44.84 (-1.139)
M3	Seat Cushion, standard DIAMOND, 2 pieces	4.50 (2.05)	+12.00 (+0.305)
M4	Seat Cushion, leather DIAMOND, 2 pieces	5.63 (2.55)	+12.00 (+0.305)
M5	*Fire Extinguisher AMEREX A 620	2.25 (1.02)	+32.25 (+0.895)
M6	Tire 5.00x5,6Ply,Main Gear(TSOC62) (including inner tube)	4.51 (2.05)	+22.45 (+0.570)
M7	Tire 15 x 6.00-5,Main Gear(Goodyear) (including inner tube)	7.70 (3.49)	+22.45 (+0.570)

* Not approved for use in all countries; check national regulations.

Refer to the Aircraft Specific Equipment list at the end of this chapter.

CHAPTER 7

DESCRIPTION OF THE AIRPLANE AND ITS SYSTEMS

7.1. INTRODUCTION	7- 2
7.2. AIRFRAME	7- 2
7.3. FLIGHT CONTROLS	7- 3
7.4. INSTRUMENT PANEL	7- 6
7.5. LANDING GEAR SYSTEM	7- 7
7.6. SEATS AND SAFETY BELTS	7- 8
7.7. BAGGAGE COMPARTMENT	7- 8
7.8. CANOPY	7- 9
7.9. POWERPLANT	7-10
7.10. FUEL SYSTEM	7-13
7.11. ELECTRICAL SYSTEM	7-15
7.12. PITOT AND STATIC PRESSURE SYSTEMS	7-18
7.13. STALL WARNING	7-18
7.14. AVIONICS	7-18

7.1. INTRODUCTION

This Chapter provides description and operation of the airplane and its systems. Refer to Chapter 9 (Supplements), for details of optional systems and equipment.

7.2. AIRFRAME

7.2.1. Fuselage

The GFRP-fuselage is of semi-monocoque construction. The fire protection cover on the fire wall is made from a special fire retarding fleece, that is covered by a stainless steel plate on the engine side. The main bulkhead is of CFRP/GFRP construction.

7.2.2. Wings

The GFRP-wings are of semi-monocoque sandwich construction, and contain a CFRP-spar. The ailerons and flaps are made from CFRP and are attached to the wings using aluminum hinges.

The wing-fuselage connection is made with three bolts each. The so-called A- and B- bolts are fixed to the fuselage's root rib. The A-bolt is placed in front of the spar tunnel, the B-bolt lies near the trailing edge. The two main bolts are placed in the middle of the spar tunnel (main bulkhead). They are accessible between the backrests and can be inserted from the front side. A spring loaded hook locks both bolt handles, thereby securing them.

7.2.3. Empennage

The rudder and elevator units are of semi-monocoque sandwich construction. The vertical stabilizer contains a dipole antenna for the number 1 com. radio, the horizontal stabilizer contains an antenna for the NAV equipment (VOR).

7.3. FLIGHT CONTROLS

The ailerons and elevator are actuated via push rods, and the rudder is controlled using control cables. The flaps have three positions (up [UP], take-off [T/O], and landing [LDG]) and are electrically operated. The switch is located on the instrument panel. In addition the flap control circuit is provided with a manually triggerable circuit breaker.

Elevator forces may be balanced using the electric trim system.

7.3.1. Trim System

The Rocker switch is located on center console behind engine control unit. The digital trim indicator is located in the middle of the instrument panel.

The switch controls an electrical actuator beside the vertical push rod in the vertical stabilizer. The actuator applies via compression springs a load on the elevator controls. Its circuit breaker is located in the circuit breaker panel and can also be triggered manually.

switch forward = nose down

7.3.2. Flaps

The flaps are driven by an electric motor. The flaps are controlled by a three position flap operating switch on the instrument panel. The three positions of the switch correspond to the position of the flaps, where the top position of the switch is used during cruise flight. When the switch is moved to a different position, the flaps move automatically until the selected position is reached. The up (fully retracted) and landing (fully extended) positions are additionally equipped with a limit switch to prevent overtraveling.

The electric flap actuator is protected by an automatic circuit breaker (3.5 A), located in the circuit breaker panel, which can also be triggered manually.

7.3.3. Flap Position Indicator

The current flap position is indicated by three control lights beside the flap operating switch.

Wing Flap Position	Light	Degree
CRUISE	green	0°
T/O	yellow	15°
LDG	yellow	40°

When two lights are illuminated at the same time, the flaps are between these two positions. This is the case while the flaps are in motion.

7.3.4. Pedal Adjustment

NOTE

The pedals may only be adjusted on the ground.

The pedals for rudder and brakes are unlocked by pulling the T-grip located on the rudder pedal sled aft pedestal.

Forward adjustment: Push both pedals forward with your feet while pulling the T-grip.

Backward adjustment: Pull pedals backward to desired position by pulling on T-grip.

NOTE

After the T-grip is released, push the pedals forward with your feet until they lock in place.

7.3.5. Flight Control Lock

A flight control lock, P/N 20-1000-01-00 , is provided with each aircraft and should be installed whenever the aircraft is parked.

NOTE

Failure to install the flight control lock whenever the aircraft is parked may result in control system damage, due to gusts or turbulence.

Installation and Removal of the Control Lock:

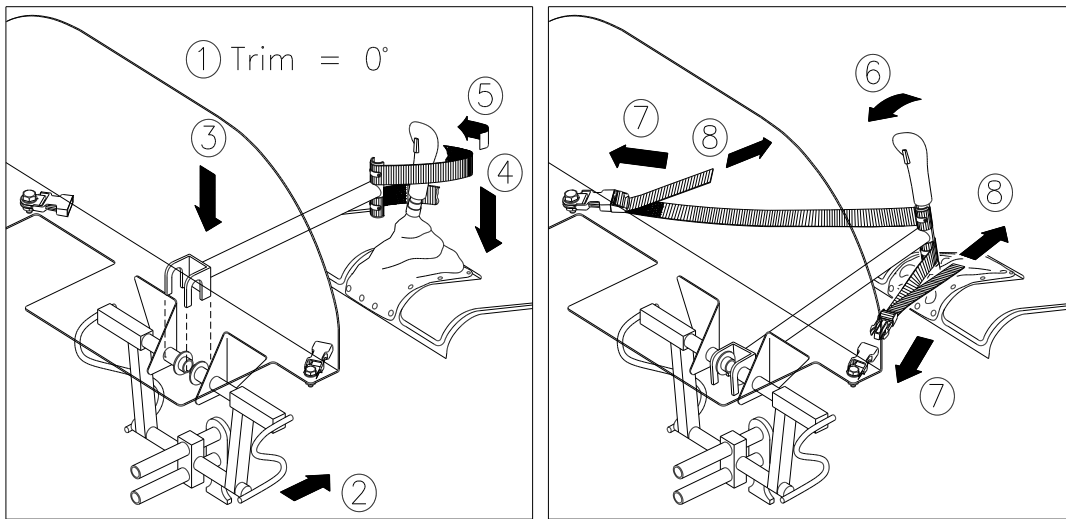

1. Trim aircraft to zero (0) degrees.
2. Pull the left rudder pedals fully aft and check they are locked in position.
3. Hook the Control Lock's forks over the rudder pedal tubes as shown above.
4. Push down the Control Stick's leather boot to expose the Control Stick tube, and push the Control Stick forward against the Control Lock.
5. Loop the straps around the Control Stick as shown, and push forward on the Control Stick.
6. Clip the straps into the left and right buckle receptacles located under the instrument panel.
7. Adjust the straps as required. Straps should be tight to secure the controls properly.
8. **TO REMOVE**, push the Control Stick forward (to relieve strap tension). Unclip the straps and remove the Control Lock. Store in the aircraft's baggage compartment.

7.4. INSTRUMENT PANEL

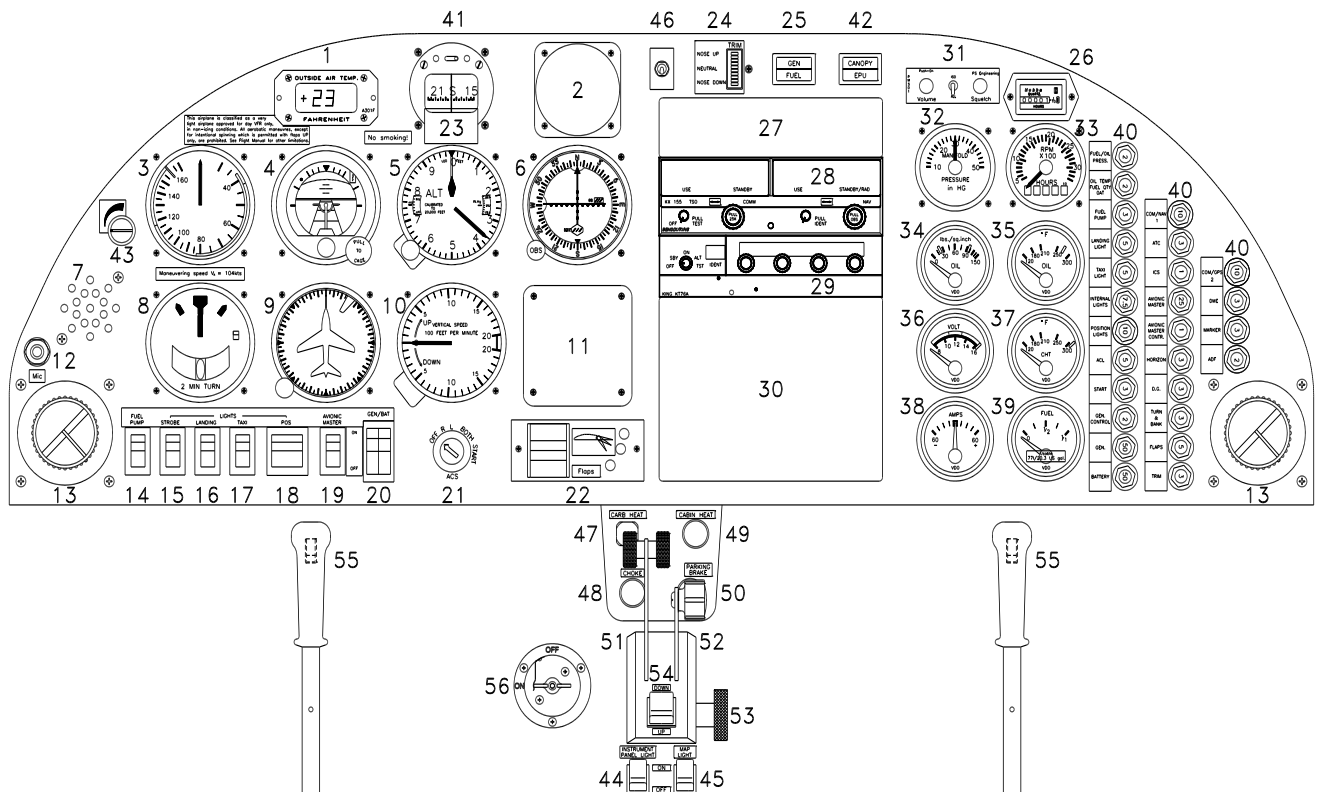

Item	Description	Item	Description	Item	Description	Item	Description
1.	Outside Air Temp. Ind.	16.	Landing Light Switch	31.	Intercom	44.	I-Panel Light Switch
2.	Not Used	17.	Taxi Light Switch	32.	Manifold Pressure	45.	Map Light Switch
3.	Air Speed Indicator	18.	Nav. Lights Switch	33.	Tachometer	46.	Trim Ind. Dimmer
4.	Artificial Horizon Ind.	19.	Avionics Master	34.	Oil Pressure Ind.	47.	Carb Heat Knob
5.	Altimeter	20.	Master Switch	35.	Oil Temp. Ind.	48.	Choke Knob
6.	CDI	21.	Ignition Switch	36.	Voltmeter	49.	Cabin Heat Knob
7.	Stall Warning Horn	22.	Flap Control	37.	Cylinder Head Temp. Indicator	50.	Parking Brake Knob
8.	Turn and Bank Ind.	23.	Compass Card	38.	Ammeter	51.	Power Lever
9.	Directional Gyro	24.	Trim Indicator	39.	Fuel Indicator	52.	Propeller RPM Lever
10.	Vertical Speed Ind.	25.	Annunciator Lights	40.	Circuit Breakers	53.	Lever Tension Knob
11.	Not Used	26.	Hobbs Meter	41.	Compass	54.	Trim Switch
12.	Microphone Jack	27.	Not Used	42.	Canopy Locking Warning Light	55.	Microphone Switch
13.	Air Vent	28.	Radio	43.	I-Panel Reostat	56.	Fuel Shut-Off Valve
14.	Fuel Pump Switch	29.	Transponder				
15.	Strobe Light Switch	30.	Not Used				

7.4.1. Flight Instruments

The flight instruments are installed on the pilot's side of the instrument panel.

7.4.2. Cabin Heat

The cabin heat and defrost system, directs ram air through the coolant radiator and the heat shroud (located around the muffler) into the heat valve. The warm air is then directed to both the window defrosting vents and to the cabin floor.

The cabin heat knob, located in front of the center console, is used to regulate the flow of heated air.

knob pulled = cabin heat ON

7.4.3. Cabin Air

The cabin aeration is controlled by two adjustable air-vent nozzles. The two sliding windows in the canopy can be opened for additional ventilation.

7.5. LANDING GEAR SYSTEM

The landing gear system consists of the two main landing gear wheels mounted to a self-spring steel strut and a free castoring nose wheel. The suspension of the nose wheel is handled by an elastomer package. The landing gear wheel fairings are removable. During flight operations without wheel fairings, partially reduced flight performance must be taken into account (see Chapter 5).

7.5.1. Wheel Brakes

Hydraulically operated disc brakes act on the wheels of the main landing gear. The wheel brakes are operated individually using the toe-brake pedals either on the pilot's or on the co-pilot's side. If either the left or right wheel brake system on the pilot's side fail, the co-pilot's brakes fail too. The same applies to a failure on the co-pilot's side, in this case, also the pilot's brakes fail.

CAUTION

When placing the feet on the brake pedals, care should be taken to not contact the structure above the pedals, which could prevent effective application of the brake(s).

7.5.2. Parking Brake

The knob is located on the center console in front of the throttle quadrant, and is pushed in when the brakes are to be released. To set the parking brake, pull the knob to the stop. Repeated pushing of the toe-brake pedals will build up the required brake pressure which will remain in effect until the parking brake is released.

7.6. SEATS AND SAFETY BELTS

The seats are removable to facilitate the maintenance and inspection of the underlying controls. Covers on the control sticks prevent loose objects to foul the controls.

The seats are equipped with removable cushions. Manually triggered seat-type parachutes may be used instead of cushions. For automatically triggered parachutes it is possible to install suitable fastening loops on the A-bolts (under the seats).

Every seat is equipped with four-point safety belt. The locking of the safety belt occurs by slipping the lap belt through the shoulder belt-ends and inserting the lap belt-end into the belt lock. The belt is opened by pulling the lock cover.

7.7. BAGGAGE COMPARTMENT

The baggage compartment is located behind the seat above the fuel tank. The baggage should be distributed evenly in the baggage compartment. The baggage net must be secured.

CAUTION

Ensure that baggage compartment limitations (44 lbs/20 kg max.) and aircraft weight and balance limitations are not exceeded.

7.8. CANOPY

Locking:

The canopy is closed by pulling down on the forward handles on the canopy frame. Locking the canopy is accomplished by pushing forward on the two locking handles on the left and right side of the frame.

CAUTION

Before starting the engine, the canopy must be closed and locked. The red handles must be moved fully forward.

After starting the engine the canopy must be closed and locked and stay closed and locked until the engine is shut down.

During engine operation it is prohibited to enter or exit the airplane.

To lock: Push both LH and RH locking handles forward.

To unlock: Pull both LH and RH locking handles backwards.

A canopy locking warning light, located in the upper center section of the instrument panel, indicates the status of the canopy's locking mechanism. If the canopy locking warning light is illuminated, the canopy is not locked properly.

In an emergency situation, the canopy can be opened from the outside LH side, by sliding the locking handle backward and pulling the emergency release lever forward to a stop and lifting up.

NOTE

The Master Switch must be ON for the Canopy Locking Warning Light to be operational.

7.9. POWERPLANT

7.9.1. Engine

Rotax 912S3, 4 cylinder, 4 stroke engine, horizontally opposed, liquid cooled cylinder heads, air cooled cylinders.

Propeller drive via integrated reduction gear (crankshaft RPM in parentheses).

Displacement: 82.5 cu.in. (1.352 liters)
 Max. T/O Power (5 min.): 100 HP / 73.5 kW at 2385 RPM (5800 RPM)
 Max. Continuous Power: 94 HP / 69 kW at 2260 RPM (5500 RPM)

Additional information can be found in the Engine Operating Manual.

The powerplant instruments are located on the instrument panel on the co-pilot's side. The ignition switch is present in form of a key switch. The ignition is turned on by turning the key to position BOTH. The starter is operated by further turning against spring load to the right (position START). The engine is shut off by the ignition switch.

Due to the backlash in the reduction gear, the propeller can be easily turned approximately 30° by hand. Sudden throttle movements should be avoided to prevent impact load in the gearbox.

7.9.2. Carburetor Heat, Throttle, Propeller Pitch Control Lever

The Throttle and Propeller Pitch Control levers are grouped together (throttle quadrant) on the center console. The tension/friction on the throttle quadrant can be adjusted using the friction knob, located on the right side of the center console. The carburetor heat knob is located in the front of the center console.

Carburetor Heat: square knob, in front of throttle in center console
 knob pulled = ON
 During normal operation the Carburetor heat is OFF (knob pushed IN)

Throttle: large lever with black conical knobs
 lever full forward = FULL throttle
 lever full rearward = IDLE

Propeller Pitch Control Lever: lever with blue notched knob, right of throttle
 lever forward = max. RPM (fine pitch)
 lever rearward = min. RPM (coarse pitch)
 (also see page 7-10).

7.9.3. Choke Small black knob below the center instrument panel (self-resetting)
 knob pulled = choke ON

7.9.4. Propeller

The HO-V352F Hoffmann Propeller is used on the DA 20/100 KATANA. The infinitely variable pitch is hydraulically controlled by a Woodward Governor. When the desired propeller RPM is preselected, the governor automatically maintains this RPM, regardless of manifold pressure and airspeed.

7.9.5. Propeller Governor

Woodward A 210786

7.9.6. Propeller Pitch Adjustment

Propeller pitch adjustments are made with the propeller pitch control lever located on the center console (throttle quadrant) to the right of the throttle. Pulling the lever backwards causes a reduction in RPM. The governor keeps the selected RPM constant regardless of airspeed or throttle setting. If the engine power level selected with the throttle is insufficient to keep the selected RPM constant, the propeller blades will move to the smallest possible pitch.

The propeller governor is mounted on the engine. It is driven directly by the engine. The propeller governor oil circuit is part of the engine oil circulation system. A defect in the governor or oil system will cause the blades to run to the minimum pitch position.

The pitch of the blades can be rotated through its pitch angle by hand.

7.9.7. Lubricating

The engine is equipped with a dry sump forced flow lubrication system. If the engine is not operated for an extended period of time, it is possible that some of the oil may drain back into the engine, resulting in a false dip stick reading.

WARNING

If the ignition key is turned to L, R, or BOTH, the respective magneto is "hot". If the propeller is moved during this time the engine may fire and cause serious or fatal injury to personnel. The possibility of a "hot" magneto may exist due to a faulty switch or aircraft wiring. Use extreme care and respect when in the vicinity of a propeller.

To check the oil level, remove the oil tank cap and turn the propeller by hand in the normal rotation of operation. This is to transfer all the oil from the engine crankcase to the oil tank.

WARNING

Do not turn the propeller in the opposite direction of normal rotation of operation.

The process is finished when crankcase air can be heard being forced back to the oil tank. The sound will be noticed as a gurgle coming from the oil tank with the oil cap removed. The sound verifies that the crankcase has been purged of residual oil. Remove the oil dip stick, clean and reinsert. Let the oil dip stick sit for a few seconds then remove verifying the oil level is in the middle of the level marks. The oil level must be between the min. and max. quantity as indicated by the flat area of the dip stick.

NOTE

Failure to recognize the above conditions could result in overfilling of the oil tank.

CAUTION

Never operate the engine with the oil filler cap removed. Observe normal procedures and limitations while running engine.

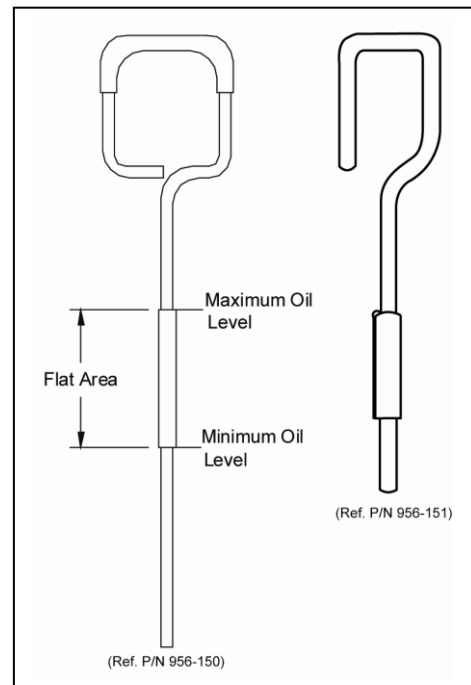

7.10. FUEL SYSTEM

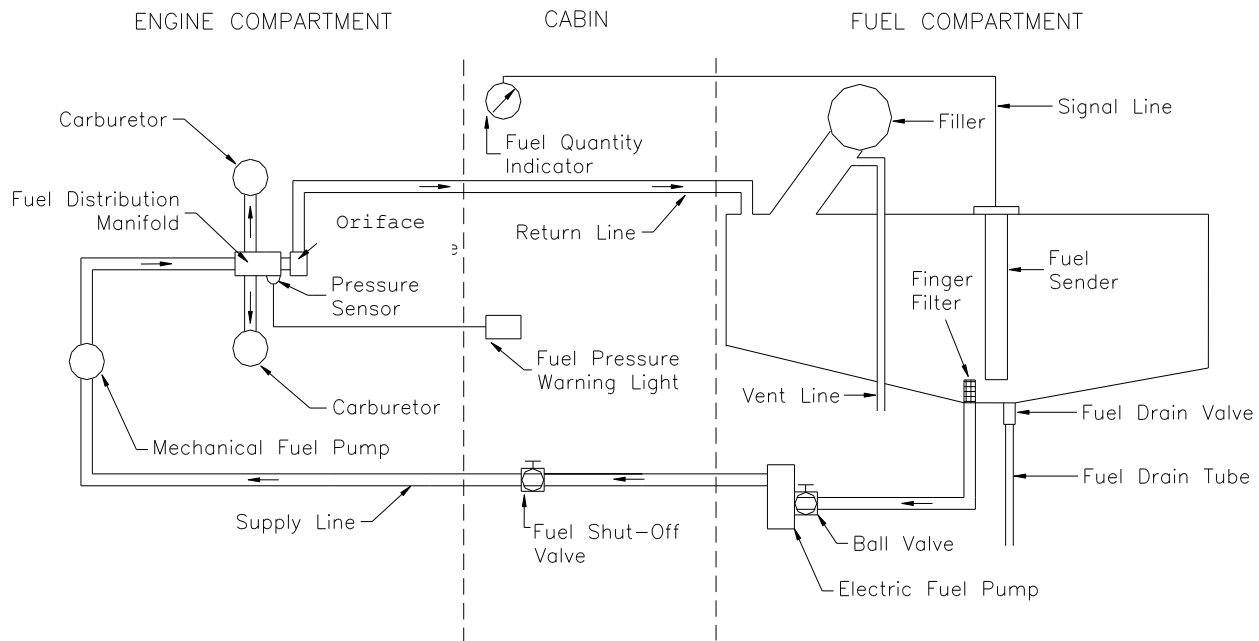

The tank, made from aluminum, is located behind the seats, below the baggage compartment. It holds 76 liters (20.1 US gal.), of which 74 liters (19.5 US gal.) are usable. The tank filler on the left side of the fuselage behind the canopy is connected to the tank with a rubber hose. The tank vent line runs from the filler connection piece through the fuselage bottom skin to the exterior of the airplane .

A finger filter is installed at the bottom of the tank. From there, the fuel is fed to the electric fuel pump, and from there, through the middle tunnel to the fuel shut-off valve. From the fuel shut-off valve it is fed to the firewall breach, and further to the mechanical fuel pump. From there, the fuel reaches the distribution manifold and finally the float chambers of both carburetors. A return line runs from the distribution manifold to the tank. Incorporated in the return line is an orifice.

A fuel pressure sensor is installed at the distribution manifold. As soon as the fuel pressure drops below 0.1 bar (1.5 psi), the fuel pressure warning light will illuminate.

7.10.1. Fuel Shut-off Valve

The fuel shut-off valve is located on the left hand side of the center console near the pilot's feet. In the open position the tap is parallel to the direction of flight. The valve is protected against unintentional shut-off by a locking detent.

WARNING

The fuel shut-off valve should only be closed during engine fire or fuel system maintenance. After reopening, the locking detent should be checked to ensure it performs the proper safety function. Otherwise the danger of operating the airplane with the fuel shut-off valve closed (engine failure) is possible!

7.10.2. Tank Drain

To drain the tank sump, activate the spring loaded drain by pushing the brass tube in with a drain container. The brass tube protrudes approx. 1 1/6 in (30 mm) from the fuselage contour and is located on the left side of the fuselage, approximately at the same station as the fuel filler cap.

7.10.3. Fuel Pipette

A fuel pipette, P/N 20-1200-02-00, is supplied with all aircraft to permit direct measurement of fuel level during the preflight check.

NOTE

Electric fuel gauges may malfunction. Check fuel quantity with fuel pipette before each flight

To check the fuel level, insert the graduated end of the fuel dipstick into the fuel tank through the fuel filler opening until it touches bottom, withdraw and read fuel quantity. The dipstick is calibrated in increments of ¼ of full tank capacity (76 liters/20.1 US gallons) .

7.11. ELECTRICAL SYSTEM

7.11.1. Power Supply

A 12 V battery is connected to the master bus via the master circuit breaker (50 Amps). The 40 amp. generator is attached to the engine near the propeller hub, recharges the battery via the generator circuit breaker (50 Amps). Both circuit breakers can be triggered manually. The generator warning light is activated by the voltage regulator monitoring circuit and illuminates when the generator is not charging the battery.

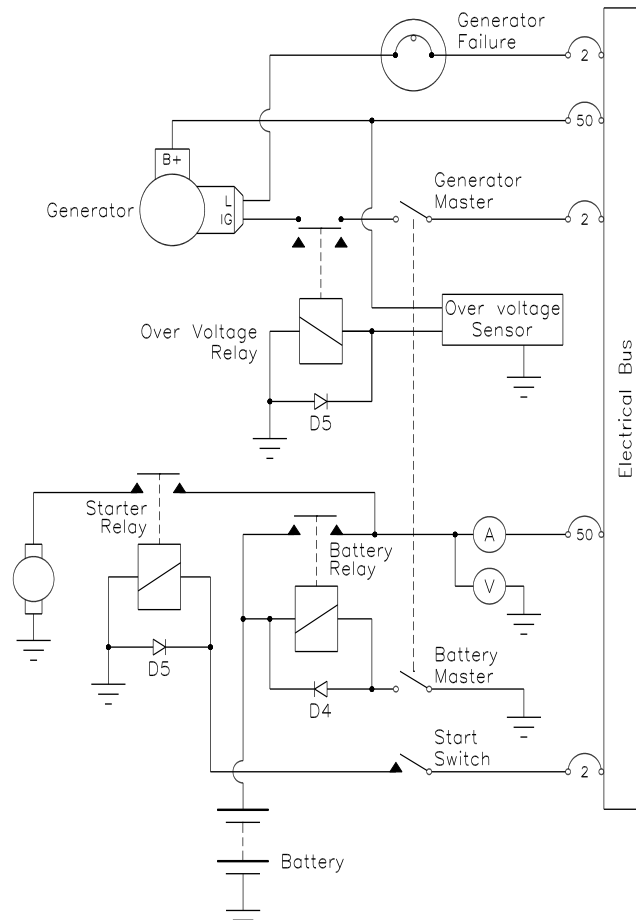

Simplified Schematic

WARNING

If the ignition key is turned to L, R or BOTH, the respective magneto is "hot". If the propeller is moved during this time the engine may fire and cause serious or fatal injury to personnel.

7.11.3. Electrical Powered Equipment

The individual consumers (e.g. Radio, Fuel Pump, Position Lights, etc.) are connected in series with their respective circuit breakers. Equipment that does not have switches installed, and requires a switch, is controlled by rocker switches in the lower left side of the instrument panel. Refer to Section 7.4 for a illustration of the instrument panel.

7.11.4 . Voltmeter

The voltmeter indicates the status of the electrical bus. It consists of a dial that is marked numerically from 8 - 16 volts in divisions of 2.

The scale is divided into three colored arcs to indicate the seriousness of the bus condition. These arcs are:

Red	for 8.0 - 11.0 volts,
Yellow	for 11.0 - 12.5 volts,
Green	for 12.5 - 16.0 volts,
Redline	at 16.1 volts.

7.11.5. Ammeter

The ammeter indicates the charging (+) and discharging (-) of the battery. It consists of a dial which is marked numerically from -60 to 60 amps.

7.11.6. Generator Warning Light

The generator warning light (red) illuminates during:

- Generator failure, no output from the generator

The only remaining power source is the battery (20 amps. for 30 minutes)

7.11.7. Fuel Pressure Indicator

As soon as the fuel pressure drops below 1.45 psi (0.1 bar), the fuel pressure switch closes, and the fuel pressure warning light illuminates.

7.11.8. Instruments

The instruments for temperatures, oil pressure, and fuel quantity are connected in series with the respective sensors. The electrical resistance of a sensor changes with the measurable variable, which causes the power to the instrument and consequently the needle deflection to change. Oil pressure indicator, cylinder head temperature indicator and fuel pressure warning light are supplied with power through one circuit breaker. Oil temperature indicator and fuel quantity indicator are also protected together by one circuit breaker.

7.11.9 Internal Lighting

The internal lighting of the DA 20/100 KATANA is provided by a lighting module located aft of the Pilot's head and on the center line of the aircraft. Included in this module are two panel illumination lights and one map light. The switches for the lights are located on the center console aft of the Trim control switch. There is a dimming control located on the left side of the instrument panel for adjusting the intensity of the panel lighting. As well there is a toggle switch located on the top center of the instrument panel that controls the intensity of the Wing Flap and Trim annunciator. A red LED mounted underneath the instrument panel, on the pilot's side, is used to illuminate the Fuel Shut Off Valve.

7.12. PITOT AND STATIC PRESSURE SYSTEMS

The pitot pressure is measured on the leading edge of a calibrated probe below the left wing. The static pressure is measured by the same probe using two holes in the lower edge and rear edge of the probe. For protection against water and humidity, water sumps are installed within the line. These water sumps are accessible beneath the left seat shell.

The error of the static pressure system is small enough to be neglected for the measuring of the altitude. For the error of the airspeed indicating system refer to Chapter 5.

The pitot static pressure probe should be protected whenever the aircraft is parked to prevent contamination and subsequent malfunction of the aircraft systems relying on its proper functioning.

NOTE

Use only the factory supplied pitot static probe cover, P/N G-659-200 with the "Remove before Flight" flag attached.

7.13. STALL WARNING SYSTEM

When the airspeed drops below 1.1 times the stall speed, a horn sounds in the left instrument panel. The horn grows louder as the speed approaches the stall speed. The horn is activated by suction on a hose that leads from a hole in the leading edge of the left wing to the horn. The hole is marked by a red circle.

The stall warning hole should be plugged whenever the aircraft is parked to prevent contamination and subsequent malfunction of the stall warning system.

NOTE

Use only the factory supplied stall warning plug, P/N 20-1010-01-00 with the "Remove before Flight" flag attached.

7.14. AVIONICS

The center of the instrument panel contains the radio and navigation equipment. The microphone key for the radio is installed in the control stick. There are two connectors for headsets on the backrest of the seat. Operating instructions for individual avionics equipment should be taken from the manuals of the respective manufacturers.

CHAPTER 8

HANDLING, PREVENTIVE AND CORRECTIVE MAINTENANCE

8.1	INTRODUCTION	8-2
8.2	AIRPLANE INSPECTION PERIODS	8-2
8.3	AIRPLANE ALTERATIONS OR REPAIRS	8-2
8.4	GROUND HANDLING / ROAD TRANSPORT	
8.4.1	Ground Handling	8-3
8.4.2	Parking	8-4
8.4.3	Mooring	8-4
8.4.4	Jacking	8-4
8.4.5	Road Transport	8-5
8.5	CLEANING AND CARE	
8.5.1	Painted Exterior Surfaces	8-6
8.5.2	Canopy	8-6
8.5.3	Propeller	8-7
8.5.4	Engine	8-7
8.5.5	Interior Surfaces, Seats and Carpets	8-7
8.6	GROUND DE-ICING	8-8

8.1. INTRODUCTION

This Chapter contains factory-recommended procedures for proper ground handling and servicing of the airplane. It also identifies certain inspection and maintenance requirements which must be followed if the airplane is to retain that new-plane performance and dependability. It is wise to follow a planned schedule of lubrication and preventive maintenance based on climatic and flying conditions encountered.

8.2. AIRPLANE INSPECTION PERIOD

Inspection intervals are every 100 hrs, 200 hrs, 1000 hrs, and 6000 hrs. of flight time. The respective maintenance procedure can be found in the Airplane Maintenance Manual.

8.3. AIRPLANE ALTERATIONS OR REPAIRS

It is essential that the responsible airworthiness authority be contacted prior to any alterations on the airplane to ensure that airworthiness of the airplane is not affected. For repairs and painting refer to the applicable Maintenance Manual Doc. No. DA201.

8.4. GROUND HANDLING / ROAD TRANSPORT

8.4.1. Ground Handling

I. Towing Forward

The airplane is most easily and safely maneuvered by hand with the tow-bar attached to the nose wheel. If the aircraft is towed forward without using the tow-bar, the nose-wheel will follow the movement of the airplane. It is recommended that the tow-bar be used to pull the aircraft forward. The DA 20/100 KATANA may also be moved forward by pushing at the trailing edge of the wing tips.

II. Moving Backward

By following a simple procedure it is very easy to move the Katana backward around the ramp. This is accomplished by pushing down with one hand on the aft section of the fuselage near the vertical stabilizer, to lift the nose wheel, while pushing back on the leading edge of the horizontal stabilizer, close to its center, with the other hand. Using this technique the DA 20/100 KATANA can easily be pushed from side to side as well as backward. If additional assistance is required, a second person may push at the leading edge of the wings.

CAUTION

Do not push or lift on Spinner!

CAUTION

Do not push on control surfaces!

8.4.2. Parking

For short time parking, the airplane must be orientated in headwind direction, the parking brake must be engaged, the wing flaps must be in the retracted position and the wheels must be chocked.

For extended and unattended parking, as well as in unpredictable wind conditions, the airplane must be anchored to the ground or placed in a hangar.

When parking the airplane, the flight controls lock, P/N 20-1000-01-00 must be installed and pitot static probe cover and stall warning plug should be fitted (ref. Chapter 7, Aircraft Description).

Parking in a hangar is recommended.

8.4.3. Mooring

The tail fin of the airplane has a hole which can be used to tie-down the airplane to the ground. Tie-down rings are also installed near the midpoint on each wing which should also be used as tie-down points.

8.4.4. Jacking

The DA 20/100 KATANA can be jacked at the two jackpoints located on the lower side of the fuselage's root ribs and at the tail fin.

8.4.5. Road Transport

For transporting the airplane on the road, it is recommended to use an open trailer. All airplane components must be stored on a cushioned surface and secured to avoid any movement during transporting.

(a) Fuselage:

The fuselage should be stored on the trailer standing on its wheels. It must be ensured that the fuselage will not move forward, backward or upward. Furthermore it must be ensured that the propeller has sufficient free space so it cannot be damaged in case the fuselage should move.

(b) Wings:

For transportation, both wings must be removed from the fuselage.

To avoid any damage, the wings are stored in upright position on the leading edge with the root rib area positioned on an upholstered profiled surface of at least 1 ft 4 in (400 mm) width. The outside wing area (approximately 10 ft (3 m) from the root rib area) is placed on an upholstered profiled surface of a minimum of 12 in (300 mm) width.

The wings must be secured to avoid any sliding movement to the rear.

c) Horizontal Stabilizer:

The horizontal stabilizer is stored flat on the trailer and secured, or in an upright position sitting on the leading edge on a profiled surface. All supports must be upholstered with felt or foam rubber.

8.5. CLEANING AND CARE

CAUTION

Excessive dirt deteriorates the flight performance.

8.5.1. Painted Surfaces

To achieve the best flight characteristics for the DA20/100 KATANA, a clean external surface is most important. For this reason it is highly recommended that the airplane, especially the leading edge of the wings are kept clean at all times.

For best result, the cleaning is performed using a generous amount of water. If necessary, a mild cleaning agent can be added. Excessive dirt such as insects etc. are best cleaned off immediately after flight, because once dried they are difficult to remove.

Approximately once a year, the surface of the airplane should be treated and buffed using a silicon free automotive polish.

CAUTION

DO NOT use any cleaning agents containing silicon based materials.

8.5.2. Canopy

The DA 20/100 KATANA offers excellent vision through a large plexiglass canopy. It is essential that care will be taken while cleaning the canopy, as it is easily scratched. If scratched, the vision will be reduced.

In principal the same rules should be applied to clean the canopy as for the outside surface of the airplane. To remove excessive dirt, plenty of water should be used; make sure to use only clean sponges and chamois. Even the smallest dust particle can cause scratches.

In order to achieve clarity, plastic cleaners such as Permatex Part No. 403D[®] or Mirror Glaze[®] may be used according to the manufacturer's instructions. Do not wipe in circles, but only in one direction.

8.5.3. Propeller

See Hoffmann Propeller Instruction Manual E540 (HO-V352).

8.5.4. Engine

See Operator's Manual for the Rotax 912 aircraft engine.

8.5.5. Interior Surfaces, Seats and Carpets

The interior should be cleaned using a vacuum cleaner. All loose items (pens, bags etc.) should be properly stored and secured. All instruments can be cleaned using a soft dry cloth, plastic surfaces should be wiped clean using a damp cloth without any cleaning agents.

8.6. GROUND DE-ICING

List of Approved De-Icing Fluids	
Manufacturer	Name
Kilfrost	TKS 80
Aeroshell	Compound 07 AL-5 (DTD 406B)

Remove the snow from the aircraft as follows:

1. Use a soft brush and remove the snow from the airplane.
2. Spray an approved de-icing fluid on ice covered surfaces with a suitable spray bottle.
3. Use a soft cloth to wipe the airplane dry after the snow and ice have been removed.

CHAPTER 9

SUPPLEMENTS

9.1	GENERAL	9-1
9.2	INDEX OF SUPPLEMENTS	9-2

9.1 GENERAL

This Chapter contains information regarding optional equipment which may be installed in your airplane. Individual supplements address each optional equipment installation. It is only necessary to maintain those supplements which pertain to your specific airplane's configuration.

9.2 INDEX OF SUPPLEMENTS

Supplement No.	Title	Pages	Revision
1	Winterization Kit	3	Revision 5

CHAPTER 9
SUPPLEMENT 1
WINTERIZATION KIT

1	GENERAL	S1-1
2	OPERATING LIMITATIONS	S1-2
3	EMERGENCY PROCEDURES	S1-2
4	NORMAL PROCEDURES	S1-2
5	PERFORMANCE	S1-3
6	WEIGHT AND BALANCE	S1-3

1. GENERAL

The Winterization kit should be installed for operations in temperatures consistently below 0°C (32°F). The kit consists of permanently installed mounting hardware and caution placards with quickly detachable oil cooler and radiator inlet baffles. The baffles partially restrict the airflow through the oil cooler and radiator to maintain optimum oil and coolant temperatures.

2. OPERATING LIMITATIONS

Maximum T/O temperature with baffles installed is 10°C(50°F).

The following placard must be located in two places, one immediately forward of the oil cooler inlet the other upon the radiator inlet baffle:



3. EMERGENCY PROCEDURES

There is no change to the airplane emergency procedures when the winterization kit is installed.

4. NORMAL PROCEDURES

Preflight Inspection:

[Insert after Item 7 (c) of the Walk-around inspection (ref. section 4.4.1 of the Airplane Flight Manual)]

- If OAT is below 0°C (32°F) install oil cooler and radiator inlet baffles (recommended),
- If OAT is above 10°C (50°F) remove oil cooler and radiator inlet baffles (**mandatory !**)

5. PERFORMANCE

There is no change in airplane performance when the winterization kit is installed.

6. WEIGHT AND BALANCE

The effect of the winterization kit on weight and balance is negligible.